

## blaugelb 1438 PZW Mortice Lock

### Product information

1438 PZW mortice lock is suitable for tube frame doors and is prepared for profile cylinders with the distance 92 mm. The 24 mm faceplate is made of stainless steel, the latch and deadbolt are nickel-plated. The latch can be reversed for left and right handing and deadbolt is single turn with a throw of 20 mm.

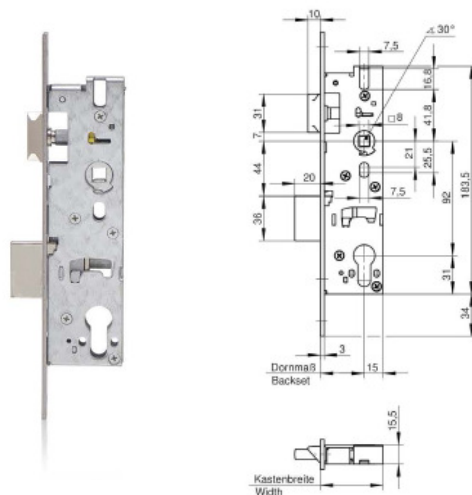

Product code	Faceplate width (mm)	Backset (mm)	Faceplate length (mm)	Spindle (mm)	Handing	Surface	Packaging unit
0390915	24	25	245	8	right or left	stainless steel	1
0390916	24	30	245	8	right or left	stainless steel	1
0390917	24	35	245	8	right or left	stainless steel	1
0390918	24	40	245	8	right or left	stainless steel	1
0390920	24	45	245	8	right or left	stainless steel	1

## blaugelb 1433 PZW Mortice Lock

### Product information

1433 PZW mortice lock is suitable for tube frame doors and is prepared for profile cylinders with the distance 92 mm. The 24 mm faceplate is made of stainless steel, the latch and deadbolt are nickel-plated. The latch can be reversed for left and right handing and deadbolt is single turn with a throw of 13 mm.

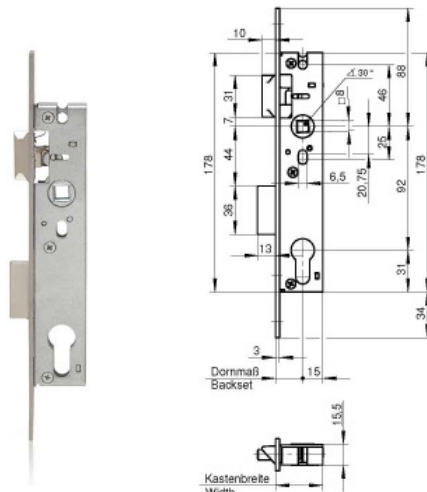

Product code	Faceplate width (mm)	Backset (mm)	Faceplate length (mm)	Spindle (mm)	Handing	Surface	Packaging unit
0390912	24	20	245	8	right or left	stainless steel	1

## blaugelb 1433 & 1438 PZW Mortice Lock Striker

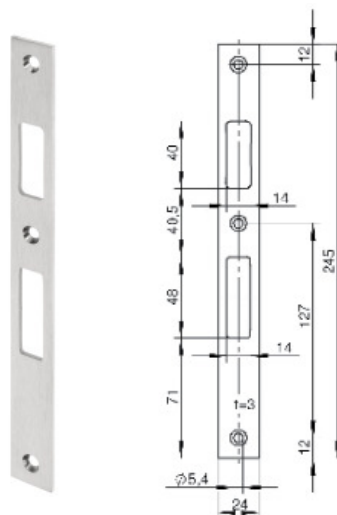

Product code	Length (mm)	Faceplate type	Handing	Surface	Packaging unit
0433235	245	square	right or left	stainless steel	1

## KFV 28 Mortice Lock

### Product information

Class 1 mortice lock for aluminium and steel doors.

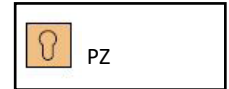
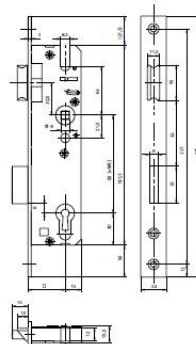

Product code	Lock type	Backset (mm)	Spindle/lock distance (mm)	Faceplate width (mm)	Faceplate length (mm)	Faceplate type	Handing	Surface	Packaging unit
3112718	PZ	30	92	24	245	square	right or left	silver coated	1
3112720	PZ	30	92	24	245	square	right or left	stainless steel	1

\* Please refer to striker plate 0129-03-24 and 8055-06-22-2.

## KFV 0129-03-24 & 8055-06-22-2 Mortice Lock Strike

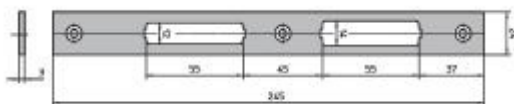

\* Please Note: 0129-03-24 above

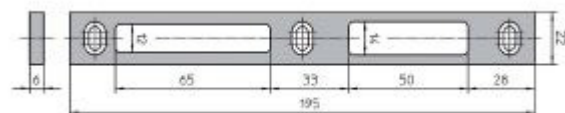

\* Please Note: 8055-06-22-2 above

Product code	Description	Length (mm)	Faceplate type	Handing	Surface	Packaging unit
3100403	0129-03-24	245	square	right or left	silver coated	1
3100404	0129-03-24	245	square	right or left	stainless steel	1
3139210	8055-06-22-2	195	square	right or left	aluminium	1

## KFV 49 Mortice Lock

### Product information

Class 3 mortice lock for aluminium and steel doors.

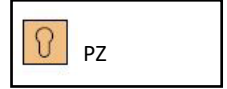
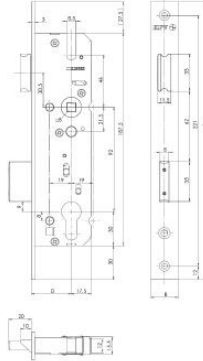

Product code	Lock type	Backset (mm)	Spindle/lock distance (mm)	Faceplate width (mm)	Faceplate length (mm)	Faceplate type	Handing	Surface	Packaging unit
3469510	PZ	30	92	24	245	square	right or left	silver coated	1
3469504	PZ	30	92	24	245	square	right or left	stainless steel	1

\* Please refer to striker plate 0129-03-24 and 8055-06-22-2.

## KFV 0129-03-24 & 8055-06-22-2 Mortice Lock Strike

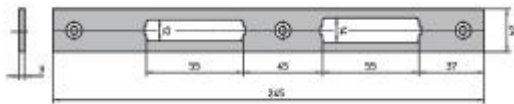

\* Please Note: 0129-03-24 above

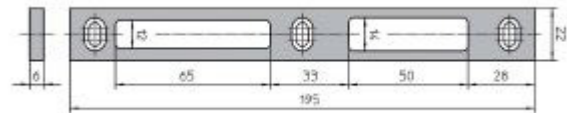

\* Please Note: 8055-06-22-2 above

Product code	Description	Length (mm)	Faceplate type	Handing	Surface	Packaging unit
3100403	0129-03-24	245	square	right or left	silver coated	1
3100404	0129-03-24	245	square	right or left	stainless steel	1
3139210	8055-06-22-2	195	square	right or left	aluminium	1

## KFV 1625 PZ Sliding Mortice Lock

### Product information

Sliding mortice lock for aluminium and steel doors.

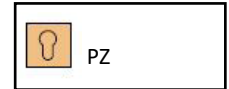
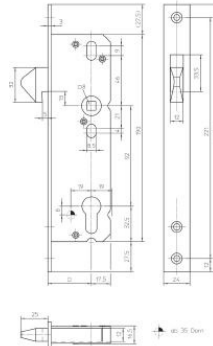

\* Please Note: Anti-lift pin (3450054 & 3360946) not pictured

Product code	Lock type	Anti-lift pin	Backset (mm)	Spindle/lock distance (mm)	Faceplate width (mm)	Faceplate length (mm)	Faceplate type	Handing	Surface	Packaging unit
3446232	PZ	no	30	92	24	245	square	right or left	silver coated	1
3309110	PZ	no	30	92	24	245	square	right or left	stainless steel	1
3450054	PZ	yes	30	92	24	245	square	right or left	silver coated	1
3360946	PZ	yes	35	92	24	245	square	right or left	silver coated	1

## KFV 0625 Sliding Mortice Lock Striker

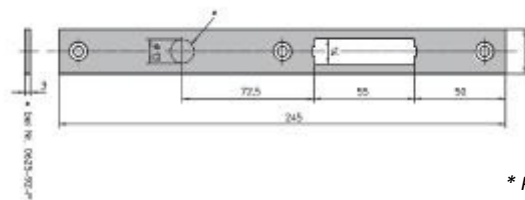

\* Please Note: Anti-lift pin striker (3483900) not pictured

Product code	Anti-lift striker	Length (mm)	Faceplate type	Handing	Surface	Packaging unit
3297605	no	245	square	right or left	silver coated	1
3297606	no	245	square	right or left	stainless steel	1
3483900	yes	245	square	right or left	silver coated	1

## KFV 1630 Sliding Mortice Lock

### Product information

Sliding mortice lock without spindle, operation via profile cylinder.

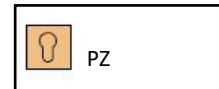
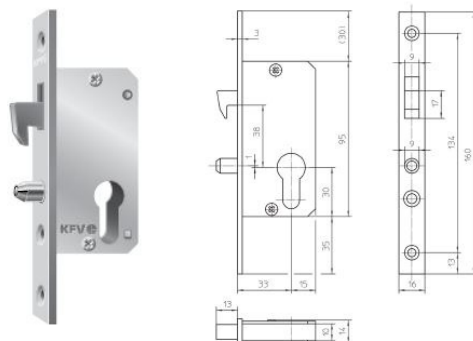

Product code	Lock type	Backset (mm)	Faceplate width (mm)	Faceplate length (mm)	Faceplate type	Handing	Surface	Packaging unit
3160955	PZ	33	16	160	square	right or left	silver coated	1

## KFV 0630 Sliding Mortice Lock Striker

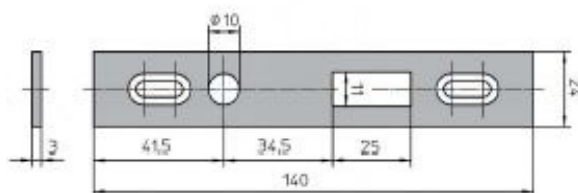

Product code	Length (mm)	Faceplate type	Handing	Surface	Packaging unit
3271323	140	square	right or left	silver coated	1