

SIEGWARE
Architectural Innovations



Consumables & Tools Catalogue

Issue: 19/6/2026

Drainage Caps	3
Adhesives	5
Construction Adhesive	5
uPVC Adhesive	7
Cyanoacrylate	8
Contact Adhesive	11
Waterproof Adhesive	13
Epoxy	14
Surface Preparation	15
Surface Activator	15
Sealant	16
Neutral Crosslinking Silicone	16
Heat Resistant Sealant	17
Fire Rated Sealant	18
General Purpose Silicone	19
Accessories	20
Sealant - Adhesive	23
General Purpose Sealant Adhesive	23
MS Adhesive Sealant	30
Fire Rated Sealant Adhesive	31
Filler	33
Expanding Foams	36
Compression Tapes	39
Cleaners	40
uPVC Cleaner	40
Aluminium Cleaner	44
All Purpose Cleaner	45
Isopropyl Alcohol (IPA)	47
Gun and Foam Cleaner	48
Hand Wipes	49
Lubricants	50
Hardware Lubricant	50
Lock Cylinder Lubricant	56
Screws & Fasteners	57
Installation Screws	57
Pan Head	57
Bullet Head	58
Countersunk	59
Construction Screws	61
Beam Screws	61
Wood Screws	63
Self Tapping Screws	68
Self Drilling Screws	70
Hardware Screws	73
Machine Screws	76
Cover Caps	77
Driver Bits	79
Threaded Inserts	81

Glazing	82
Glazing Blocks - Thickness: 1mm	82
Glazing Blocks - Thickness: 2mm	83
Glazing Blocks - Thickness: 3mm	84
Glazing Blocks - Thickness: 4mm	85
Glazing Blocks - Thickness: 5mm	86
Glazing Blocks - Thickness: 6mm	87
Tools	88
Tools	91
Driver Bits	91
Drill Bits	95
Foam Guns	103
Caulking Guns	107
Sausage Guns	109
Pistol Gun	111
Installation	112
Saws	123
Saw Blades	126
Jigsaw Blades	129
Rulers & Levels	131
Speciality Knives	133
Straps	142
Scissors	146
Chisels	148
Clamps	149
Misc	150
Service Set	163
Accessories	164
Fixing Wedges	164
Wax Repair Kit	165
U Packers	166
Transporter Blocks	167
Packing Blankets	168
Safety Glasses	169
Gloves	170
Earmuffs	173
Cable Ties	174
Cloths	176
Misc	177

Softline 36 Drainage Caps

Drainage caps for uPVC window and door systems.

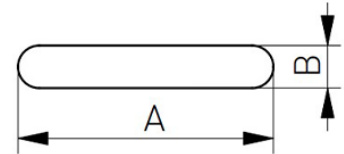
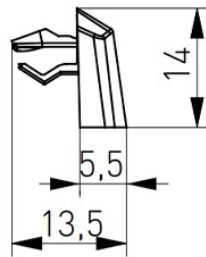
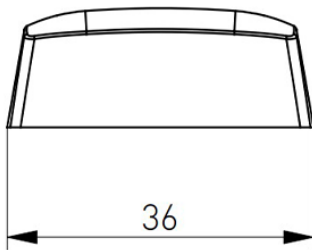

Size	Min.	Max.
A	29	30
B	4,6	5,0

Product Code	(RAL code) Colour	Box Qty
31390160100	9016 white	1000
31380030100	8003 clay brown	1000
31380030100H	8003 clay brown	1000
31370160100	7016 anthracite grey	1000
31390050100	9005 black	100
31390050100H	9005 black	1000
31370010100	7001 silver grey	100
31380770100	8077 brown	100
31390010100	9001 cream	100
31310020100	1002 Sand yellow	100
31330030100	3003 Ruby red	100
31330050100	3005 Wine red	100
31330110100	3011 Brown red	100
31350110100	5011 Steel blue	100
31360090100	6009 Fir green	100
31370000100	7000 Squirrel grey	100
31370120100	7012 Basalt grey	100
31370150100	7015 Slate grey	100
31370380100	7038 Agate grey	100
31370390100	7039 Quartz grey	100
31370470100	7047 Telegrey	100
31380010100	8001 Ochre brown	100
31380170100H	8017 Chocolate brown	1000
31380190100H	8019 Grey brown	1000

*Note: Spoffline 46mm available on request.

Catalogue not up to date?

Scan the QR or [click here](#) to view the latest version



[Click to jump back to top](#)

Softline 36 Drainage Cap Display

Desktop display with all colour variations



Product Code	Description	Packaging Unit
INN000557	Softline Drain Cap Display	1



Catalogue not up to date?
Scan the QR or [click here](#)
to view the latest version

[Click to jump back to top](#)

Ramsauer Adhesive 620

620 Konstruktions Kleber Rapid construction adhesive is very fast, silicone-free and cures with air humidity or residual moisture (e.g. in timber) to form a highly resistant joint. Suitable for timber, metals, fire-resistant building slabs, containers, ventilation and air conditioning systems, etc. The adhesive can be covered with paint coats, can be ground, and it is waterproof.



Product Code	Description	Colour	Size (mL)	Packaging Unit
4050300	Construction adhesive 620	off white	310	20



Catalogue not up to date?
Scan the QR or [click here](#)
to view the latest version

[Click to jump back to top](#)

Corfix Duo Adhesive

A two-component, polyurethane solvent-free adhesive designed for structural bonding of aluminum frame and sash corners. Can be used for pressure bonding of all kinds of insulating materials, gypsum board, FGK plates with steel, concrete.

Accessories for Corefix Duo:

- Dual barrel pistol to suit Corefix Duo - Part Code: 50400009000
- Static mixing nozzle - Part Code: 50400000000



Product Code	Description	Colour	Size (gr)	Packaging Unit
50411119000N	Adhesive	beige	900	10
50411119000SZ	Adhesive	grey	900	10
50400000000	Static mixer	N/A	N/A	1



Catalogue not up to date?
Scan the QR or [click here](#)
to view the latest version

[Click to jump back to top](#)

blaugelb uPVC Adhesive

Used for uPVC profiles, suitable for ABS and ASA, moisture and temperature resistant, weather and UV resistant.



Product Code	Description	Colour	Size (gr)	Packaging Unit
9017100	uPVC glue	transparent	180	1
9017101	uPVC glue	white	180	1



Catalogue not up to date?
Scan the QR or [click here](#)
to view the latest version

[Click to jump back to top](#)

blaugelb CA 5 Instant Adhesive

Suitable for PMMA and acrylic surfaces including APTK, EPDM, solid and cellular rubber, and synthetic elastomers. Fast curing, weather and UV resistant. Do not use on porous or absorbant surfaces.



Product Code	Description	Type	Size (gr)	Packaging Unit
0008435	CA5 instant adhesive	low viscosity	20	1
0008436	CA5 VL instant adhesive	medium viscosity	20	1



Catalogue not up to date?
Scan the QR or [click here](#)
to view the latest version

[Click to jump back to top](#)

2C Adhesive

2C Adhesive is a two pack system consisting of a high viscosity cyanoacrylate adhesive and an aerosol activator.



Product Code	Description	Glue Size (g)	Activator Size	Packaging Unit
135624	2C Adhesive Kit	100	400mL	1



Catalogue not up to date?
Scan the QR or [click here](#)
to view the latest version

[Click to jump back to top](#)

CyanoFix Gel

Cyano GEL is a non dripping gel type adhesive for the fast bonding of materials which are not exactly matching. The adhesive has a longer open time than regular cyano acrylates. The product is moisture curing.

Suitable for bonding metals, rubber, plastics, leather, wood, etc.



Product Code	Description	Glue Size (g)	Packaging Unit
116390	CyanoFix Gel	3	1



Catalogue not up to date?
Scan the QR or [click here](#)
to view the latest version

[Click to jump back to top](#)

Contact Adhesive Liquid

A ready to use, universal liquid contact adhesive for bonding most materials to a variety of surfaces.

Features and benefits:

- High adhesive strength
- Fast Cure

Suitable for the fast bonding of e.g. plastics, metal, timber, porcelain, cork, leather, ceramics, cardboard, paper and rubber.



Product Code	Description	Glue Size (mL)	Packaging Unit
100033	Contact Adhesive Liquid	50	1



Catalogue not up to date?
Scan the QR or [click here](#)
to view the latest version

[Click to jump back to top](#)

Contact Adhesive Gel

Soudal contact Gel adhesive is a universal, toluene free, ready to use thixotropic contact adhesive based upon rubber and synthetic resins.



Product Code	Description	Glue Size (mL)	Packaging Unit
104808	Contact adhesive gel	50	1



Catalogue not up to date?
Scan the QR or [click here](#)
to view the latest version

[Click to jump back to top](#)

Soudal Waterproof PU Adhesive

Waterproof PU Adhesive expands slightly during curing to fill gaps and has an extremely high strength, rigid once cured. It will set hard in about 3 hours and even bonds to wet surfaces.



Product Code	Description	Glue Size (g)	Packaging Unit
130318	Waterproof adhesive	750	6



Catalogue not up to date?
Scan the QR or [click here](#)
to view the latest version

[Click to jump back to top](#)

Epofix 82A

Epofix 82A is a fast curing 2K-Epoxy adhesive.

Features and benefits:

- Easy-to-use dual cartridge
- Fast curing
- High strength
- Fast strength development

Epofix is suitable for bonding a wide variety of materials including porcelain, metals, wood, ceramic, glass, plastics etc.



Product Code	Description	Glue Size (mL)	Packaging Unit
100071	2K-Epoxy Adhesive	24	1



Catalogue not up to date?
Scan the QR or [click here](#)
to view the latest version

[Click to jump back to top](#)

Surface Activator

Surface Activator is a degreaser and adhesion promoter. Improves adhesion on non porous substrates and raises final strength of MS and SMX based sealants. Suitable for powder coated and anodised aluminum profiles.

Applications:

- Degreasing surfaces in sealant- or bonding applications.
- Improving the adhesion on powder coated aluminum (window profiles), both for regular as for textured powder coatings.
- Improving the adhesion on various plastics: PVC, ABS, PP



Product Code	Description	Bottle Size (mL)	Packaging Unit
101638	Surface activator	500	1



Catalogue not up to date?
Scan the QR or [click here](#)
to view the latest version

[Click to jump back to top](#)

Ramsauer 120 Silicone

120 Neutral is particularly suitable for sealing insulating glass in timber frames with water dilutable paint systems, as well as for sealing connection joints. Adheres well without primer, compatible with paint coats, abrasion-free. Tested to DIN 18545, Part 2, Group E and EN ISO 11600, Class G25LM. In accordance with DIN 18540, Part 1. Fulfills the requirements of LEED and DGNB.



Product Code	Description	Colour	Size (mL)	Packaging Unit
1100301	Neutral crosslinking silicone	transparent	310	20
1100302	Neutral crosslinking silicone	white	310	20
1100303	Neutral crosslinking silicone	black	310	20
1100305	Neutral crosslinking silicone	bronze	310	20
1100308	Neutral crosslinking silicone	oak	310	20
1100390	Neutral crosslinking silicone	clay brown	310	20



Catalogue not up to date?
Scan the QR or [click here](#)
to view the latest version

[Click to jump back to top](#)

Silirub HT°-A

Silirub HT°-A is an elastic, single component engineering sealant based on silicone which withstands very high temperatures.

Benefits:

Excellent adhesion on metals, glass and glazed substrates

Typical acetic smell

Permanently elastic after curing.

Temperature resistance up to 285°C

Application:

Sealing of heating installations. - Sealing in pumps and engines. - All sealing applications that require high temperature resistance.



Product Code	Description	Colour	Size (mL)	Packaging Unit
108265	Heat resistant Silicon	Black	310	12



Catalogue not up to date?
Scan the QR or [click here](#)
to view the latest version

[Click to jump back to top](#)

Firecryl FR

Firecryl FR is a fire-resistant, smoke-tight, with heat load intumescent plasto-elastic sealant based on acrylic dispersion.

Features & Benefits:

- Prevents the passage of fire and smoke
- Intumesces when exposed to temperatures higher than 120°C
- Can be painted over after curing
- Very easy to apply
- Permanently elastic after curing
- Colourfast and waterproof after curing
- Very good adhesion on many porous materials

Applications:

- Fire-resistant and smoke-tight indoor applications.
- As part of the 'Soudal Fire Range' assortment for penetration seals and joints.
- Sealing of fire retardant joints in walls and ceiling.
- Fire-restardant filling of cracks in concrete and plasterwork.
- Applications where the sealant needs to be overpainted with water based paints and varnishes.



Product Code	Description	Colour	Volume (ml)	Packaging Unit
131479	310 mL cartridge	Grey	310	12
131478	600 mL sausage	Grey	600	12



Catalogue not up to date?
Scan the QR or [click here](#)
to view the latest version

[Click to jump back to top](#)

Soudal All Purpose Silicone

For all sealing, waterproofing and bonding applications where protection against mould and mildew is required. The ultimate all rounder silicone suitable to the broadest range of applications. Offers strong adhesion to ceramics, glass, aluminium (including powder coated & anodised), PVC, stainless steel, zinc & galvanised coated surfaces, timber, concrete, fibreglass, laminate, painted surfaces, etc.



Product Code	Old Product Code	Colour	Colorbond Equivalent	Size (mL)	Box Qty
175867	121671	Alabaster	-	300	12
175868	121662	Clear/Translucent	-	300	12
175870	121663	Beige	Paperbark	300	12
175871	121995	Black	Night Sky	300	12
175873	121661	Brilliant White	White Haven	300	12
175879	121668	Charcoal	Monument	300	12
175886	121666	Dark Grey	Windspray	300	12
175895	121669	Stone	Gully	300	12
176431	127785	Titantium	Surfmist	300	12



Catalogue not up to date?
Scan the QR or [click here](#)
to view the latest version

[Click to jump back to top](#)

Ramsauer 45 Degree Adaptor



Product Code	Description	Packaging Unit
9310004	45 Degree adaptor	1



Catalogue not up to date?
Scan the QR or [click here](#)
to view the latest version

[Click to jump back to top](#)

Ramsauer Square Nozzle



Product Code	Description	Packaging Unit
9330000	Square nozzle	1



Catalogue not up to date?
Scan the QR or [click here](#)
to view the latest version

[Click to jump back to top](#)

Soudal Multi Tool

Easy to use universal scraper to remove old sealant joints. Made out of special material to avoid damage to the surface.



Product Code	Description	Packaging Unit
119352	Multi tool	1



Catalogue not up to date?
Scan the QR or [click here](#)
to view the latest version

[Click to jump back to top](#)

Soudal FIX ALL Crystal

Fix ALL® Crystal: The perfect product if you are in search of a sealant-gluе with same strong properties as the Fix ALL® Classic and is also 100% transparent and paintable.

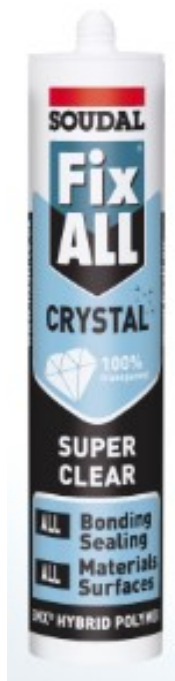

Product Code	Description	Colour	Size (mL)	Packaging Unit
168149	Polymer adhesive sealant	clear/transparent	290	12



Catalogue not up to date?
Scan the QR or [click here](#)
to view the latest version

[Click to jump back to top](#)

Soudal FIX ALL High Tack

Fix ALL® High Tack: The perfect product if you are in search of a sealant-gue with an EXTREMELY HIGH INITIAL TACK as well as good sealing qualities.



Product Code	Description	Colour	Size (mL)	Packaging Unit
101459	Fixall High Tack	Black	290	12
122625	Fixall High Tack	White	290	12



Catalogue not up to date?
Scan the QR or [click here](#)
to view the latest version

[Click to jump back to top](#)

Soudal FIX ALL Turbo

Fix ALL® Turbo is a high quality single component adhesive-sealant based on SMX®-Polymer with very fast build-up of strength.



Product Code	Description	Colour	Size (mL)	Packaging Unit
168148	Fixall Turbo	White	290	12



Catalogue not up to date?
Scan the QR or [click here](#)
to view the latest version

[Click to jump back to top](#)

Soudal Multibond SMX25 Flex and Seal

Multibond SMX25 is a high quality, low modulus, single component, permanently highly flexible, joint sealant with higher viscosity. Perfect for internal & external applications. Based on SMX® Polymer SMX25 has a “Shore A” hardness of 25 and can accommodate movement of ± 25%. SMX25 has excellent UV resistance, elasticity and can be sanded and painted with most types of paint. Once cured forms a strong, flexible, waterproof seal and bonds to the widest range of substrates. SMX25 can be used for damp and wet surfaces.



Product Code	Description	Colour	Size (mL)	Packaging Unit
130249	SMX 25 Flex and Seal	Dark Grey	600	1
130254	SMX 25 Flex and Seal	Black	600	1



Catalogue not up to date?
Scan the QR or [click here](#)
to view the latest version

[Click to jump back to top](#)

Soudal Multibond SMX35 Seal and Stretch

Multibond SMX35 is a high quality, single component, permanently flexible joint sealant. Perfect for internal & external applications. Based on SMX® Polymer Multibond SMX35 has a “Shore A” hardness of 35 and can accommodate movement of ± 20 %. Multibond SMX35 has excellent UV resistance, elasticity and can be sanded and painted with most types of paint. Once cured forms a strong, flexible, waterproof seal and bonds to the widest range of substrates. Multibond SMX35 can be used for damp and wet surfaces.



Product Code	Description	Colour	Size (mL)	Packaging Unit
124598	SMX 35 Seal and Stretch	White	600	12
124619	SMX 35 Seal and Stretch	Black	600	12
124605	SMX 35 Seal and Stretch	Concrete Grey	290	12
124790	SMX 35 Seal and Stretch	Dark Grey	600	12



Catalogue not up to date?
Scan the QR or [click here](#)
to view the latest version

[Click to jump back to top](#)

T-Rex Crystal

T-Rex Crystal is a high quality, crystal clear, neutral, elastic, single component sealant/adhesive based on SMX®-Polymer.



Product Code	Description	Colour	Size (mL)	Packaging Unit
121969	sealant/adhesive	Clear	290	12



Catalogue not up to date?
Scan the QR or [click here](#)
to view the latest version

[Click to jump back to top](#)

Isocell Airstop Sprint Sealant

Odourless, quick-drying sealant for permanent elastic sealing of gaps and joints between building components and overlaps of membranes in drywall constructions.

Product advantages:

- High initial adhesive properties
- No dripping
- No priming required
- Adhesion to wood, stone, concrete, plaster and various metals.



Product Code	Description	Colour	Size (mL)	Packaging Unit
3SPRINT310	Airstop Sprint Sealant	Beige	310	1



Catalogue not up to date?
Scan the QR or [click here](#)
to view the latest version

[Click to jump back to top](#)

Isocell Uni MS Adhesive Sealant

UV-resistant, permanently elastic, water resistant MS-Polymer based sealant that can be painted over. For sealing and bonding a wide variety of materials throughout the house, indoors and outdoors such as window joints.

Product advantages:

- Permanently elastic
- Temperature resistance: -40° to +90°
- Non-corrosive to metals
- Free from solvents, silicon and isocyanate
- Water & UV resistant
- Joint filling and non foaming
- Workable on damp substrates



Product Code	Description	Colour	Size (mL)	Packaging Unit
3MS310S	Uni MS Adhesive Sealant	Black	310	1
3MS290	Uni MS Adhesive Sealant	White	310	1



Catalogue not up to date?
Scan the QR or [click here](#)
to view the latest version

[Click to jump back to top](#)

Soudal Soudaseal FR

Soudaseal FR is a high-quality, fire-resistant, smoke-tight, neutral, elastic, one component joint and adhesive sealant based on SMX Polymer (Hybrid).

Applications:

- Fire retardant expansion and connection joints in the construction industry.
- Sealing of fire-retardant joints in prefab buildings and skyscrapers.
- Flexible connections in automotive applications.
- As part of the 'Soudal Fire Range' assortment for penetration seals and joints.



Product Code	Description	Colour	Size (mL)	Package Type	Packaging Unit
137450	Soudaseal FR	Grey	310	Cartridge	1
131480	Soudaseal FR	Grey	600	Sausage	1



Catalogue not up to date?
Scan the QR or [click here](#)
to view the latest version

[Click to jump back to top](#)

Soudal Soudafoam FR HY

Soudafoam FR HY (High Yield) is a high quality, one-component fire rated / resistance, self-expanding, ready to use polyurethane foam, where the canister is provided with a thread so it can be used on a gun.



Product Code	Description	Colour	Size (mL)	Package Type	Packaging Unit
153085	Soudafoam FR HY	Pink	750	Gun Grade	12



Catalogue not up to date?
Scan the QR or [click here](#)
to view the latest version

[Click to jump back to top](#)

Fill & Paint Gap Filler

Soudal Trade Fill & Paint Gap Filler is a high-quality, plasto-elastic one-component joint sealant based on acrylic dispersion.

Features and Benefits:

- Very easy to apply
- Colourfast and waterproof after curing
- Can be painted over, after curing
- Very good adhesion on many porous surfaces and aluminium

Applications:

- Joints on window sills, between plinths and walls, between masonry, ...
- Joints with movement till max. 10%
- Filling of cracks in concrete and plasterwork



Product Code	Description	Colour	Size (mL)	Packaging Unit
174920	Gap Filler	White	300	12

*Replaces 122394



Catalogue not up to date?
Scan the QR or [click here](#)
to view the latest version

[Click to jump back to top](#)

Soudal Universal Bog

Universal BOG is a two-component polyester putty based on unsaturated polyester resins.



Product Code	Description	Size (g)	Colour	Packaging Unit
121174	Bog	50	NA	5
132560	Bog	750	Ivory	12



Catalogue not up to date?
Scan the QR or [click here](#)
to view the latest version

[Click to jump back to top](#)

All Weather Flex Gap Filler

All Weather Flex gap filler is a highly flexible, exterior grade, paintable acrylic gap filler that cures to form an extremely durable seal. All Weather Flex is ideal for use as a gap filler for high stress applications and for external use due to superior flexibility and high weather resistance.



Product Code	Description	Size (ml)	Packaging Unit
129181	Gap Filler	300	12



Catalogue not up to date?
Scan the QR or [click here](#)
to view the latest version

[Click to jump back to top](#)

Soudal Pro Expanding Foam Gun Grade

Soudal Pro Expanding Foam Gun Grade is a one-component, self-expanding, ready-to-use polyurethane foam supplied in a threaded canister for application with a foam gun. It contains HCFC- and CFC-free propellants that are environmentally friendly and do not harm the ozone layer. Equipped with Duravalve technology, the product maintains optimal yield throughout its shelf life, even when stored or transported horizontally.

The foam is ideal for installing window and door frames, filling gaps and cavities, and sealing openings in roof structures. It can also be used to create acoustic barriers and enhance thermal insulation in refrigeration and cooling systems.



Product Code	Size (ml)	Colour	Box Quantity
175406	750	Champagne	12



Catalogue not up to date?
Scan the QR or [click here](#)
to view the latest version

[Click to jump back to top](#)

Genius Gun Flexible Insulation Foam

A flexible polyurethane based expanding foam with a specially designed patented trigger mechanism ensuring precise dosage and removing the need for an additional gun.



Product Code	Description	Size (ml)	Packaging Unit
130425	Insulation foam	750	12



Catalogue not up to date?
Scan the QR or [click here](#)
to view the latest version

[Click to jump back to top](#)

Soudal Flexible Insulation Foam – Gun Grade

Flexible Insulation Expanding Foam Gun Grade is a one-component, self-expanding, ready to use polyurethane foam with elastic properties, which allow the foam to follow the movement of the joint and keep its insulation properties for many years. Because of the Duravalve, the optimal yield remains over the entire shelf life, even when stored or transported lying down. Flexible Insulation Expanding Foam Gun is filled with HCFC- and CFC-free propellants which are not harmful for the ozone layer.

Features & Benefits

- 3 times more flexible than standard PU foam
- Airtight (see IFT-report)
- Water Vapour Open
- Excellent stability (no shrinkage or post-expansion)
- High filling capacity
- Good adhesion on all surfaces (except PE, PP and PTFE).
- High insulation value, thermal and acoustic



Product Code	Description	Size (ml)	Packaging Unit
117472	Flexi Foam - Blue	750	12



Catalogue not up to date?
Scan the QR or [click here](#)
to view the latest version

[Click to jump back to top](#)

blaugelb Joint Sealing Tape 300

Used for sealing strip joints and window installations, suitable for joint widths between 2-6mm, 5-12mm, and 9-20mm

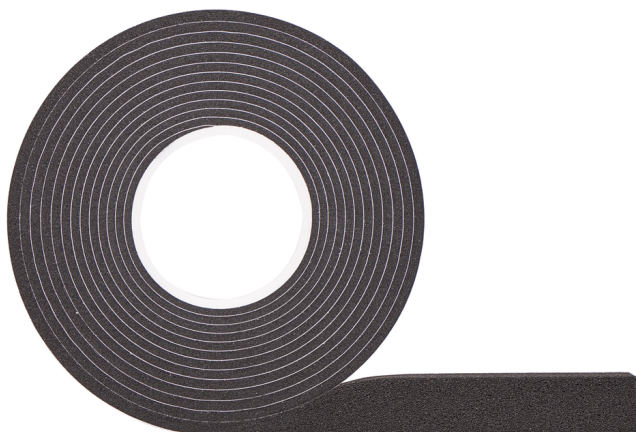

Product Code	Description	Joint Width (mm)	Width (mm)	Length (m)	Packaging Unit
0418858	Installation compression tape	5-12	20	5	15
0418860	Installation compression tape	9-20	20	3	15



Catalogue not up to date?
 Scan the QR or [click here](#)
 to view the latest version

[Click to jump back to top](#)

blaugelb uPVC Cleaner S5

Dissolving cleaner for deep scratches and marks on white uPVC profile.

Product advantages:

- Highly dissolving
- Cleans thoroughly
- Compensates for hairline cracks on the surface
- Suitable for polishing ground corner welds
- Specifically designed for PVC hard white in production areas
- UVA system for high protection against weather influences
- Reduced recontamination
- Has an anti-static effect



Product Code	Description	Size (litre)	Packaging Unit
0008458	uPVC 5 cleaner	1	1



Catalogue not up to date?
Scan the QR or [click here](#)
to view the latest version

[Click to jump back to top](#)

blaugelb uPVC Cleaner S10

Removes marks, small scratches & dirt particles from white uPVC profile.

Product advantages:

- Cleans thoroughly
- Suitable for hard white uPVC parts such as frames, cover caps and strips
- Intended for use in production and assembly areas
- Thoroughly cleans dirt, rubber traces, pencil marks, adhesive residues, fresh PU foam, silicone sealant (in fresh condition).
- Prepares surfaces for bonding
- Has an anti-static effect

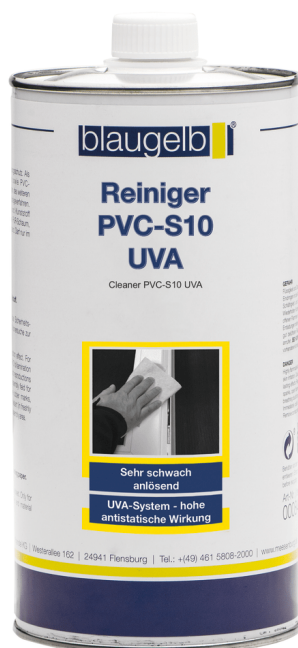

Product Code	Description	Size (litre)	Packaging Unit
0008430	uPVC 10 cleaner	1	1



Catalogue not up to date?
Scan the QR or [click here](#)
to view the latest version

[Click to jump back to top](#)

blaugelb uPVC Cleaner S20

Non dissolving cleaner with weatehr protection for PVC surfaces. Removes dust, protective film adhesive residue, pencil marks, and finger smudges from uPVC and Renolit products.

Product advanages:

- Non-dissolving
- Cleans thoroughly and gently
- Suitable for PMMA and acrylate-coated substrates
- UVA system for high protection against weathering
- Anti-static effect
- Reduces re-soiling



Product Code	Description	Size (litre)	Packaging Unit
0008438	uPVC 20 cleaner	1	1



Catalogue not up to date?
Scan the QR or [click here](#)
to view the latest version

[Click to jump back to top](#)

blaugelb uPVC Frame Cleaner

Gentle cleaner for coloured (foiled) and white uPVC surfaces. The cleaner has an antistatic property that makes the surface dirt repellent.

Product features:

- Cleans oil and grease
- Non-dissolving
- Water based
- Phosphate free
- Reduces recontamination
- Biodegradable

Note: Not suitable for water-based paint surfaces.



Product Code	Description	Size (mL)	Packaging Unit
0008444	uPVC Cleaner - Coloured	500	1
0008443	uPVC Cleaner - White	500	1



Catalogue not up to date?
Scan the QR or [click here](#)
to view the latest version

[Click to jump back to top](#)

blaugelb Alu-ELP Cleaner

The blaugelb cleaner Alu-ELP cleans the profile surfaces made of anodized and powder-coated aluminum thoroughly and gently. In window and door construction, it is used for general final cleaning and removal of marking aids.

Product Advantages:

- Thorough cleaning
- For use in production and assembly
- Designed for use on anodised and powder-coated surfaces
- ELP additive system for special protection of the surface
- Free of aromatic compounds



Product Code	Description	Size (litre)	Packaging Unit
0008432	Aluminium Cleaner	1	1



Catalogue not up to date?
Scan the QR or [click here](#)
to view the latest version

[Click to jump back to top](#)

blaugelb Bio All Purpose Cleaner

The blaugelb organic all-purpose cleaner is a water-based alkaline universal cleaner for the removal of stubborn dirt such as grease, oil, resin, wax, nicotine, pencil, ballpoint pen, felt-tip pen, ink, algae, mold, soot, insects, bitumen and tar splashes, coffee and tea stains, shoe polish and much more.

Product Advantages:

- Surfactants easily biodegradable according to OECD criteria
- Cleans thoroughly and gently
- Highly concentrated
- Phosphate-free
- Water-based
- Non-flammable
- Non-abrasive



Product Code	Description	Size (litre)	Packaging Unit
0130397	All Purpose Bio Cleaner	1	1



Catalogue not up to date?
Scan the QR or [click here](#)
to view the latest version

[Click to jump back to top](#)

Soudal Cleaner & Degreaser

Cleaner and Degreaser is a powerful quickdrying cleaner and degreaser for various maintenance and assembly jobs. Suitable for cleaning and degreasing mechanical parts. Also suitable for the preparation of surfaces. For the application of sealants or adhesives. For the removal of uncured excess MS, PU or silicone sealants, tar residue, grease and wax. Can be used on most surfaces (metal, plastics, PVC,...) and leaves no residue.



Product Code	Description	Size (mL)	Packaging Unit
119708	Cleaner and degreaser	400	6



Catalogue not up to date?
Scan the QR or [click here](#)
to view the latest version

[Click to jump back to top](#)

blaugelb IPA10 Cleaner

The blaugelb Cleaner IPA 10 has a strong degreasing effect and is suitable for light to medium soiling, e.g. grease, dust, oil.

Product Advantages:

- Effortlessly removes light and medium dirt such as dust, grease, oil
- Ventilates quickly
- Excellent for time-critical applications due to its fast processability
- Suitable for all common surfaces, including powder-coated surfaces, various plastics, (coated) glass, aluminum, ceramics, silicones, PTFE, PP, PE* (*It is recommended to carry out preliminary test on inconspicuous surface before wider application).



Product Code	Description	Size (litre)	Packaging Unit
0414735	IPA Cleaner	1	12



Catalogue not up to date?
Scan the QR or [click here](#)
to view the latest version

[Click to jump back to top](#)

Soudal Gun and Foam Cleaner

For cleaning and removing fresh PU foam from foam guns and other surfaces.

Product advantages:

- Can be screwed into foam guns for easy cleaning
- Can be sprayed onto surfaces with attached spray nozzle
- Free from HCFC/CFC propellants



Product Code	Description	Size (mL)	Packaging Unit
106310	Gun and Foam Cleaner	750	1



Catalogue not up to date?
Scan the QR or [click here](#)
to view the latest version

[Click to jump back to top](#)

Stroxx Multipurpose Wipes

Multipurpose antibacterial wipes. Perfect for cleaning grease, silicon and dirt.



Product Code	Description	Size	Packaging Unit
0009123121	Multipurpose Wipes	250 cloths	1



Catalogue not up to date?
Scan the QR or [click here](#)
to view the latest version

[Click to jump back to top](#)

blaugelb Hardware Fitting Spray

A special maintenance and care agent for all movable fitting parts and the mechanics on windows, doors, gates and garages. The hardware spray effectively protects against dirt and corrosion, extends the service life of the hardware components and reduces the risk of consequential damage.

Product advantages:

- Effectively protects against wear and dirt
- Loosens stuck mechanisms
- Does not attach paints and PMMA films
- Has an antistatic effect
- Is free of resin and acids, gentle on metal surfaces
- Silicone-free
- Has a permanent corrosion-protecting effect
- No run-off from mechanical parts
- Resistant to salt water



Product Code	Description	Volume (ml)	Packaging Unit
0008446	Fitting spray	100	12



Catalogue not up to date?
Scan the QR or [click here](#)
to view the latest version

[Click to jump back to top](#)

MDS Protect - Hardware Oil

Professional lubricant oil dedicated to window and door fittings.

- Product benefits:
- Reduces friction
- Safe for protective coatings on fittings
- Neutral when in contact with plastics
- Non-staining
- Odorless
- Colourless



Product Code	Volume (ml)	Packaging Unit
800MDSP100	100	1
800MDSP15	15	1

*The image is of the 100ml variant



Catalogue not up to date?
Scan the QR or [click here](#)
to view the latest version

[Click to jump back to top](#)

Soudal Silicon Spray

Silicone Spray is a transparent spray with lubricating and anti-adhesive characteristics based on high-grade silicone oil.

Reduces friction and reduces wear on mechanical parts and is therefore suitable for light lubrication of metals, plastics and rubbers.

Gives plastics and rubber a glossy finish.



Product Code	Description	Size (mL)	Packaging Unit
119704	Silicon Spray	400	6



Catalogue not up to date?
Scan the QR or [click here](#)
to view the latest version

[Click to jump back to top](#)

Soudal Silicon Spray

PTFE Spray is a high-grade lubricant based on PTFE for the treatment of metal and plastic parts. Does not contain silicones and is suitable for indoor and outdoor use.



Product Code	Description	Size (mL)	Packaging Unit
119705	PTFE Spray	400	6



Catalogue not up to date?
Scan the QR or [click here](#)
to view the latest version

[Click to jump back to top](#)

Soudal Multi Spray 8:1

Multi spray is a high-quality universal spray with 8-fold action: rust dissolver, lubricant, cleaner, water-repellent, penetrating oil, corrosion resistant, contact spray, shock spray.

Applications:

- To be used for machines, roller bearings, axles, cogwheels, conveyer belts, rubber gasket profiles
- Is corrosion-resistant. Has a penetrating action and a protective film remains after cleaning
- Does not attack rubber, plastics or metals.



Product Code	Description	Size (mL)	Packaging Unit
119707	Multi Spray 8:1	400	6



Catalogue not up to date?
Scan the QR or [click here](#)
to view the latest version

[Click to jump back to top](#)

Soudal Contact Spray

Universal cleaning and maintenance spray for electric contacts. Dissolves dirt and oxides and restores contact.



Product Code	Description	Size (mL)	Packaging Unit
119715	Contact spray	400	1



Catalogue not up to date?
Scan the QR or [click here](#)
to view the latest version

[Click to jump back to top](#)

blaugelb Lock Cylinder Spray

The locking cylinder spray is the universal care product for locks and locking cylinders with a special, non-greasy formula. It protects against water, icing, corrosion and wear. Also suitable for other moving mechanical parts.

Product advantages:

- Effectively protects against water and dirt
- Non dirt binding
- Silicone free
- Fast creep under metal parts
- Permanent corrosion protecting effect
- Free of CHC, CFC, chlorene, lead and other pollutants.



Product Code	Description	Size (mL)	Packaging Unit
0370698	Cylinder spray	50	20



Catalogue not up to date?
Scan the QR or [click here](#)
to view the latest version

[Click to jump back to top](#)

blaugelb Pan Head Installation Screws

A universal fastener for the dowelless, efficient assembly of components made of timber, uPVC, aluminum and timber/aluminum in various substrates (concrete, sand-lime brick, solid brick, timber, lightweight concrete, aerated concrete, high-hole brick).

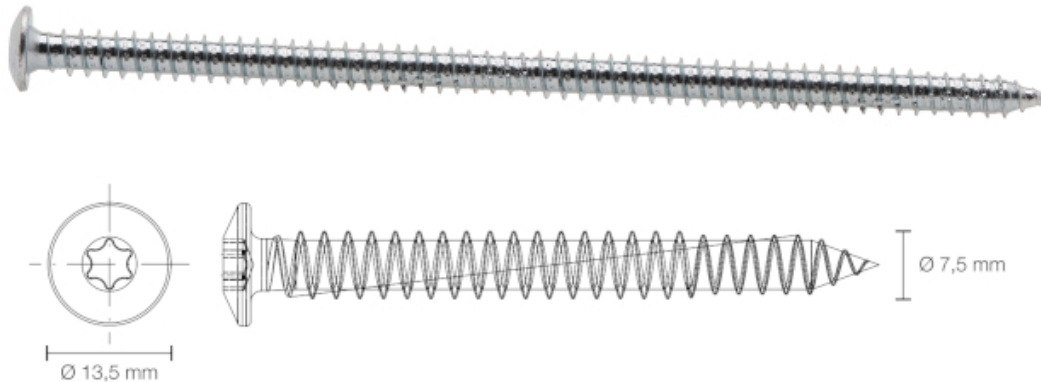

Product Code	Description	Driver	Thickness (mm)	Head (mm)	Box Quantity
0422314	Window installation screws	TX30	7.5 x 62	13.5	100
0422319	Window installation screws	TX30	7.5 x 82	13.5	100
0422321	Window installation screws	TX30	7.5 x 102	13.5	100
0422325	Window installation screws	TX30	7.5 x 122	13.5	100
0422329	Window installation screws	TX30	7.5 x 152	13.5	100

*Note: Various driver bits are available. Please refer to drivers section at the end of this catalogue.



Catalogue not up to date?
Scan the QR or [click here](#)
to view the latest version

[Click to jump back to top](#)

blaugelb Bullet Head Installation Screws

Fully threaded bullet head frame screws for window installation

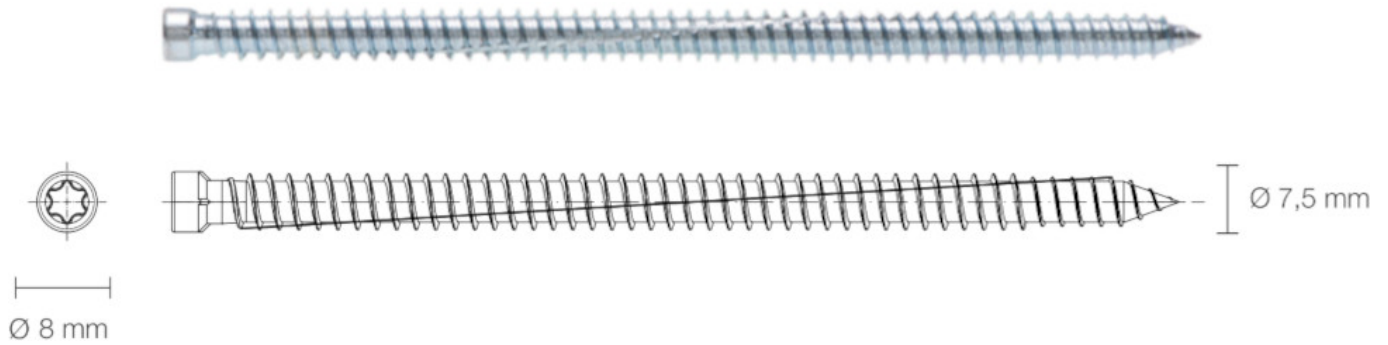

Product Code	Description	Driver	Size (mm)	Head (mm)	Box Quantity
0423709	Window installation screws	TX30	7.5 x 62	8	100
0423711	Window installation screws	TX30	7.5 x 82	8	100
0423713	Window installation screws	TX30	7.5 x 102	8	100
0423715	Window installation screws	TX30	7.5 x 122	8	100
0423717	Window installation screws	TX30	7.5 x 152	8	100
0423719	Window installation screws	TX30	7.5 x 212	8	100

*Note: Various driver bits are available. Please refer to drivers section at the end of this catalogue.



Catalogue not up to date?
Scan the QR or [click here](#)
to view the latest version

[Click to jump back to top](#)

Parco Window Installation Screws - Countersunk Head

Countersunk window installation screws.



Product Code	Description	Driver	Size (mm)	Head (mm)	Box Quantity
604175X42	Window installation screws	TX30	7.5 x 42	11.5	100
604175X62	Window installation screws	TX30	7.5 x 62	11.5	100
604175X82	Window installation screws	TX30	7.5 x 82	11.5	100
604175X100	Window installation screws	TX30	7.5 x 100	11.5	100
604175X120	Window installation screws	TX30	7.5 x 120	11.5	100
604175X152	Window installation screws	TX30	7.5 x 152	11.5	100
604175X182	Window installation screws	TX30	7.5 x 182	11.5	100

*Note: Various driver bits are available. Please refer to drivers section at the end of this catalogue.



Catalogue not up to date?
Scan the QR or [click here](#)
to view the latest version

[Click to jump back to top](#)

Fischer® Window Installation Screws - Countersunk Head

Countersunk window installation screws.



Product Code	Description	Driver	Size (mm)	Head (mm)	Box Quantity
532922	Window installation screws	TX30	7.5 x 42	11.5	100
532925	Window installation screws	TX30	7.5 x 62	11.5	100
532928	Window installation screws	TX30	7.5 x 82	11.5	100
532931	Window installation screws	TX30	7.5 x 102	11.5	100
532934	Window installation screws	TX30	7.5 x 122	11.5	100
532941	Window installation screws	TX30	7.5 x 152	11.5	100
532942	Window installation screws	TX30	7.2 x 182	11.5	100

*Note: Various driver bits are available. Please refer to drivers section at the end of this catalogue.



Catalogue not up to date?
Scan the QR or [click here](#)
to view the latest version

[Click to jump back to top](#)

Parco® Timber Beam Construction Screw

Beam construction screws. Wide variety of lengths. Optimised cutting tip, no washers required.

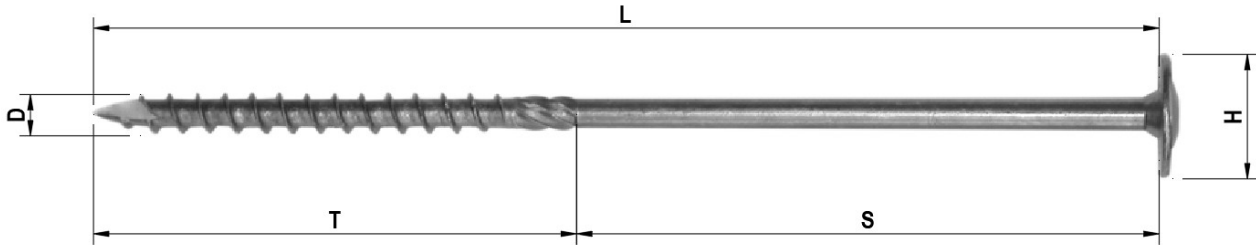

Product Code	Size (mm)	Head (mm)	Thread (mm)	Shank (mm)	Driver	Material	Box Quantity
116T6X50	6 x 50	15	30	10	TX30	Blue Galvanised Steel	100 pcs
116T6x70	6 x 70	15	50	20	TX30	Blue Galvanised Steel	100 pcs
116T6x100	6 x 100	15	70	30	TX30	Blue Galvanised Steel	100 pcs
116T6x120	6 x 120	15	90	30	TX30	Blue Galvanised Steel	100 pcs
116T6x160	6 x 160	15	90	70	TX30	Blue Galvanised Steel	100 pcs
116T6x200	6 x 200	15	90	110	TX30	Blue Galvanised Steel	100 pcs
116T6x260	6 x 260	15	90	170	TX30	Blue Galvanised Steel	100 pcs
116T6x300	6 x 300	15	90	210	TX30	Blue Galvanised Steel	100 pcs
116T8x100	8 x 100	15	70	30	TX40	Blue Galvanised Steel	50 pcs
116T8x120	8 x 120	15	90	30	TX40	Blue Galvanised Steel	50 pcs
116T8x160	8 x 160	15	90	70	TX40	Blue Galvanised Steel	50 pcs
116T8x200	8 x 200	15	90	110	TX40	Blue Galvanised Steel	50 pcs
116T8x260	8 x 260	15	90	170	TX40	Blue Galvanised Steel	50 pcs
116T8x300	8 x 300	15	90	210	TX40	Blue Galvanised Steel	50 pcs
116T8x360	8 x 360	15	90	270	TX40	Blue Galvanised Steel	50 pcs
116T8x400	8 x 400	15	90	310	TX40	Blue Galvanised Steel	50 pcs

*Note: Various driver bits are available. Please refer to drivers section at the end of this catalogue.



Catalogue not up to date?
Scan the QR or [click here](#)
to view the latest version

[Click to jump back to top](#)

Parco® Timber Beam Construction Screw (A2 STAINLESS)

Stainless steel beam construction screws. Wide variety of lengths. Optimised cutting tip, no washers required.

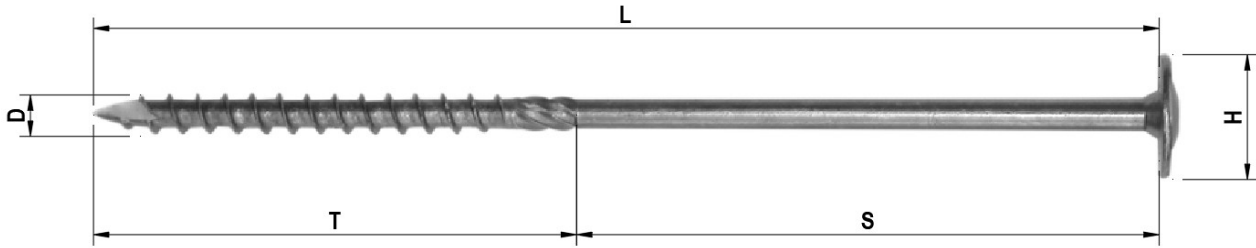

Product Code	Size (mm)	Head (mm)	Thread (mm)	Shank (mm)	Driver	Material	Box Quantity
117TE6x50	6 x 50	15	30	20	TX25	Stainless Steel	100 pcs
117TE6x70	6 x 70	15	50	20	TX25	Stainless Steel	100 pcs
117TE6x100	6 x 100	15	70	30	TX25	Stainless Steel	100 pcs
117TE6x120	6 x 120	15	70	50	TX25	Stainless Steel	100 pcs
117TE6x160	6 x 160	15	70	90	TX25	Stainless Steel	100 pcs
117TE8X50	8 x 50	20	50	0	TX40	Stainless Steel	100 pcs
117TE8X100	8 x 100	20	80	20	TX40	Stainless Steel	100 pcs
117TE8X120	8 x 120	20	80	20	TX40	Stainless Steel	50 pcs
117TE8X160	8 x 160	20	80	80	TX40	Stainless Steel	50 pcs
117TE8X200	8 x 200	20	80	120	TX40	Stainless Steel	50 pcs
117TE8X300	8 x 300	20	80	220	TX40	Stainless Steel	50 pcs
117TE8X400	8 x 400	20	80	320	TX40	Stainless Steel	50 pcs

*Note: Various driver bits are available. Please refer to drivers section at the end of this catalogue.



Catalogue not up to date?
Scan the QR or [click here](#)
to view the latest version

[Click to jump back to top](#)

Original JetFast® Timber Construction Screws - Yellow Galvanised

Double flat head screw featuring ribs under the head for clean, smooth sinking. Multi furrows on the shank offer a lower screw-in and screw-out torque, and a cutting end for deep, splinter proof drilling.



Product Code	Size (mm)	Thread (mm)	Shank (mm)	Driver	Material	Box Quantity
116045X40N	4.5 x 40	24	16	TX20	Yellow Galvanised Steel	500 pcs
116045X50N	4.5 x 50	30	20	TX20	Yellow Galvanised Steel	200 pcs
116045X60N	4.5 x 60	36	24	TX20	Yellow Galvanised Steel	200 pcs
116045X70N	4.5 x 70	42	28	TX20	Yellow Galvanised Steel	200 pcs
116045X80N	4.5 x 80	48	32	TX20	Yellow Galvanised Steel	200 pcs
11605X40N	4.5 x 40	24	16	TX20	Yellow Galvanised Steel	200 pcs
11605X50N	5 x 50	30	20	TX20	Yellow Galvanised Steel	200 pcs
11605X60N	5 x 60	36	24	TX20	Yellow Galvanised Steel	200 pcs
11605X70N	5 x 70	42	28	TX20	Yellow Galvanised Steel	100 pcs
11605X80N	5 x 80	48	32	TX20	Yellow Galvanised Steel	100 pcs
11605X90N	5 x 90	54	36	TX20	Yellow Galvanised Steel	100 pcs
11605X100N	5 x 100	60	40	TX20	Yellow Galvanised Steel	100 pcs
11606X50N	6 x 50	30	20	TX30	Yellow Galvanised Steel	200 pcs
11606X60N	6 x 60	35	25	TX30	Yellow Galvanised Steel	200 pcs
11606X70N	6 x 70	45	25	TX30	Yellow Galvanised Steel	200 pcs
11606X80N	6 x 80	50	30	TX30	Yellow Galvanised Steel	100 pcs
11606X90N	6 x 90	55	35	TX30	Yellow Galvanised Steel	100 pcs
11606X100N	6 x 100	60	40	TX30	Yellow Galvanised Steel	100 pcs
11606X120N	6 x 120	70	50	TX30	Yellow Galvanised Steel	100 pcs
11606X150N	6 x 150	70	80	TX30	Yellow Galvanised Steel	100 pcs
11606X180N	6 x 180	108	72	TX30	Yellow Galvanised Steel	100 pcs
11606X200N	6 x 200	120	80	TX30	Yellow Galvanised Steel	100 pcs

*Note: Various driver bits are available. Please refer to drivers section at the end of this catalogue.



Catalogue not up to date?
Scan the QR or [click here](#)
to view the latest version

[Click to jump back to top](#)

Original JetFast® Timber Construction Screws - Silverline

Double flat head screw featuring ribs under the head for clean, smooth sinking. Multi furrows on the shank offer a lower screw-in and screw-out torque, and a cutting end for deep, splinter proof drilling.



Product Code	Size (mm)	Thread (mm)	Shank (mm)	Driver	Material	Box Quantity
11504X30N	4 x 30	8	12	TX20	Silverline	1000
115045X60N	4.5 x 60	36	24	TX20	Silverline	200
115045X70N	4.5 x 70	42	28	TX20	Silverline	100
11505x70N	5 x 70	42	28	TX20	Silverline	100
11506X100N	6 x 100	60	40	TX30	Silverline	100
11506X120N	6 x 120	72	48	TX30	Silverline	100

*Note: Various driver bits are available. Please refer to drivers section at the end of this catalogue.



Catalogue not up to date?
Scan the QR or [click here](#)
to view the latest version

[Click to jump back to top](#)

blaugelb Stainless Steel Universal Wood Screw

Stainless steel (A2) universal wood screw. Sliding coating for effortless driving. Mill ribs at tip.



Product Code	Size (mm)	Driver	Material	Box Quantity
0271509	5 x 100	T25	Stainless Steel	200
0271493	5 x 40	T25	Stainless Steel	200
0271504	5 x 70	T25	Stainless Steel	200

*Note: Various driver bits are available. Please refer to drivers section at the end of this catalogue.



Catalogue not up to date?
Scan the QR or [click here](#)
to view the latest version

[Click to jump back to top](#)

blaugelb Universal Wood Screw

Universal wood screw. Sliding coating for effortless driving. Mill ribs at tip.

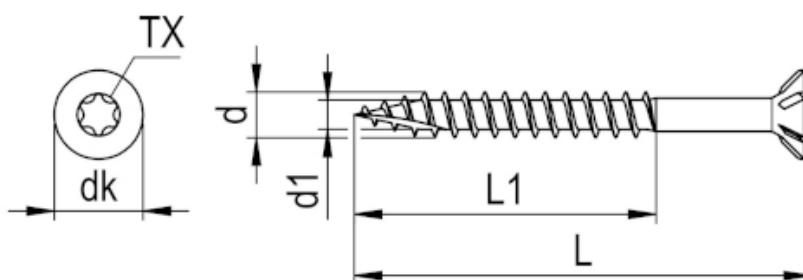

Product Code	Size (mm)	Head (mm)	Material	Box Quantity
0203844	6 x 100	T30	Galvanised	100
0203850	6 x 140	T30	Galvanised	100
0203840	6 x 60	T30	Galvanised	200
0203841	6 x 70	T30	Galvanised	200

*Note: Various driver bits are available. Please refer to drivers section at the end of this catalogue.



Catalogue not up to date?
Scan the QR or [click here](#)
to view the latest version

[Click to jump back to top](#)

Parco® Span Fast Chipboard Screws

Partially threaded chipboard screws.

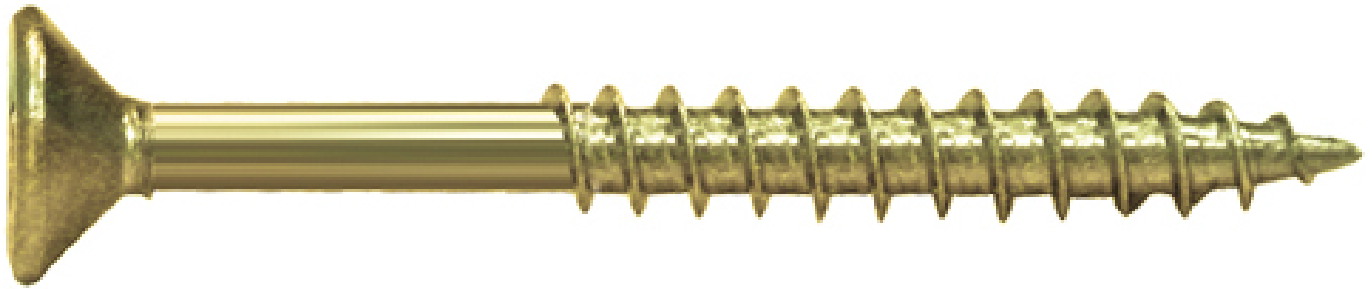

Product Code	Size (mm)	Driver	Material	Box Quantity
1094T40	4.0 x 40	TX20	Yellow Galvanised Steel	500
10945T50	4.5 x 50	TX25	Yellow Galvanised Steel	200
1095X70	5.0 x 70	TX25	Yellow Galvanised Steel	100
1096X100	6.0 x 100	TX30	Yellow Galvanised Steel	100

*Note: Various driver bits are available. Please refer to drivers section at the end of this catalogue.



Catalogue not up to date?
Scan the QR or [click here](#)
to view the latest version

[Click to jump back to top](#)

Self Tapping A2 Stainless Steel Screws

Self tapping screw with a 16mm washer.
Hex Driver



Product Code	Size (mm)	Driver	Material	Box Quantity
29563x115	6.3 x 115	Hex	A2 Stainless Steel	100



Catalogue not up to date?
Scan the QR or [click here](#)
to view the latest version

[Click to jump back to top](#)

Parco® Self Tapping Metal Screw

Self tapping metal screw with silverline zinc coating.



Product Code	Size (mm)	Head (mm)	Driver	Material	Box Quantity
17848X45	4.8 x 45	9.5	PH2	Silverline	500 pcs
17848X50	4.8 x 50	9.5	PH2	Silverline	500 pcs
17848X60	4.8 x 60	9.5	PH2	Silverline	250 pcs
17848X70	4.8 x 70	9.5	PH2	Silverline	250 pcs
17848X80	4.8 x 80	9.5	PH2	Silverline	250 pcs
17848X100	4.8 x 100	9.5	PH2	Silverline	250 pcs
17848X120	4.8 x 120	9.5	PH2	Silverline	250 pcs

*Note: Various driver bits are available. Please refer to drivers section at the end of this catalogue.



Catalogue not up to date?
Scan the QR or [click here](#)
to view the latest version

[Click to jump back to top](#)

EJOT Self Drilling Screw

Self tapping window construction screw with millribs for optimal use with window reinforcement.



Product Code	Size (mm)	Head (mm)	Driver	Material	Box Quantity
0312899	4.0 x 13	7.5	PH2	Steel	1000

*Note: Various driver bits are available. Please refer to drivers section at the end of this catalogue.



Catalogue not up to date?
Scan the QR or [click here](#)
to view the latest version

[Click to jump back to top](#)

blaugelb Self Drilling Screw

Self tapping window construction screw with millribs for optimal use with window reinforcement.

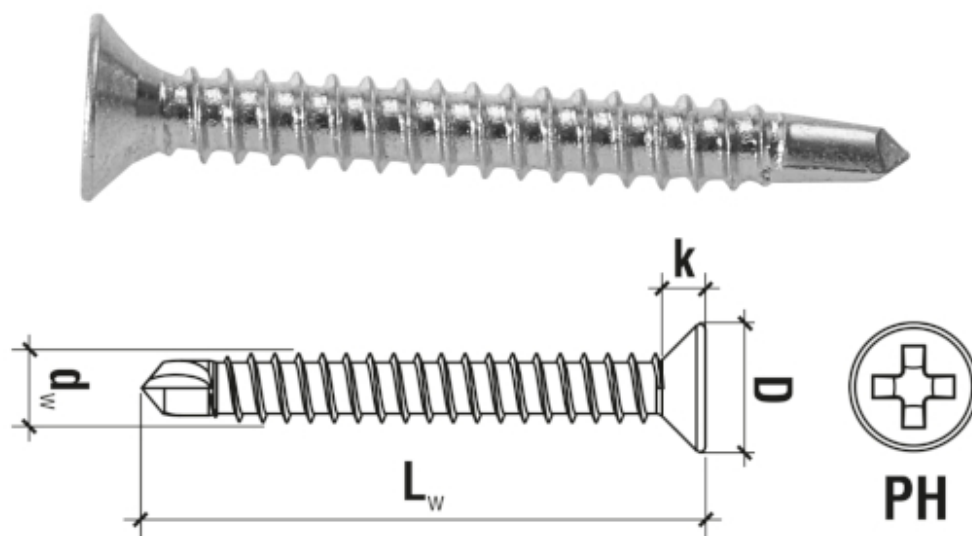

Product Code	Size (mm)	Head (mm)	Driver	Material	Box Quantity
9051274	3.9 x 16	7.5	PH2	Galvanised	1000 pcs
9051275	3.9 x 19	7.5	PH2	Galvanised	1000 pcs
9051276	3.9 x 25	7.5	PH2	Galvanised	1000 pcs
9051277	3.9 x 32	7.5	PH2	Galvanised	500 pcs
9051278	3.9 x 40	7.5	PH2	Galvanised	500 pcs

*Note: Various driver bits are available. Please refer to drivers section at the end of this catalogue.



Catalogue not up to date?
Scan the QR or [click here](#)
to view the latest version

[Click to jump back to top](#)

E- NORMPRO Pan Head Sheet Metal Screw

Galvanised pan head sheet metal screw.

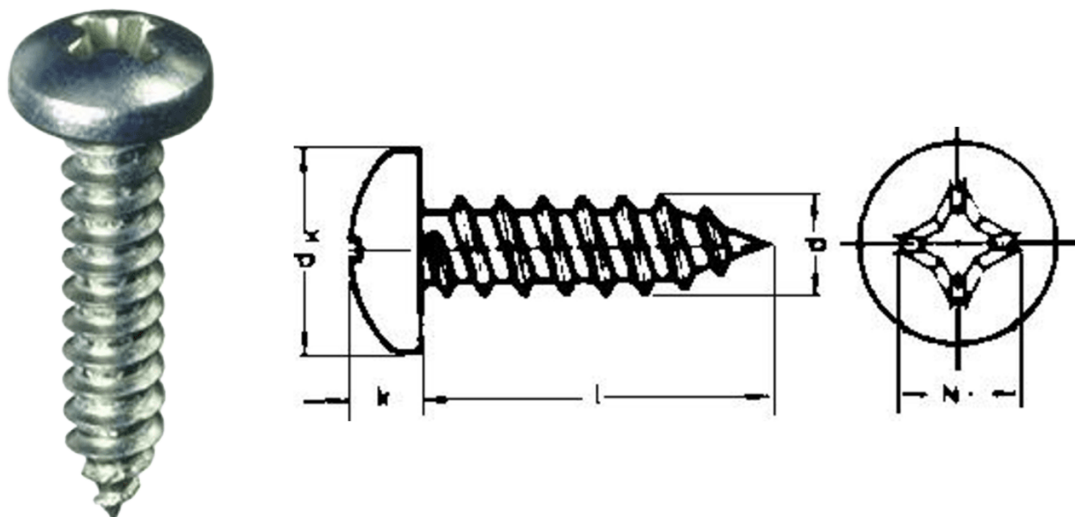

Product Code	Size (mm)	Head (mm)	DIN	Driver	Box Quantity
6606015780	4.8 x 25	9.5	798	PH2	100

*Note: Various driver bits are available. Please refer to drivers section at the end of this catalogue.



Catalogue not up to date?
Scan the QR or [click here](#)
to view the latest version

[Click to jump back to top](#)

blaugelb uPVC Hardware Screw

Needle point hardware fixing screw for optimal use in uPVC window construction

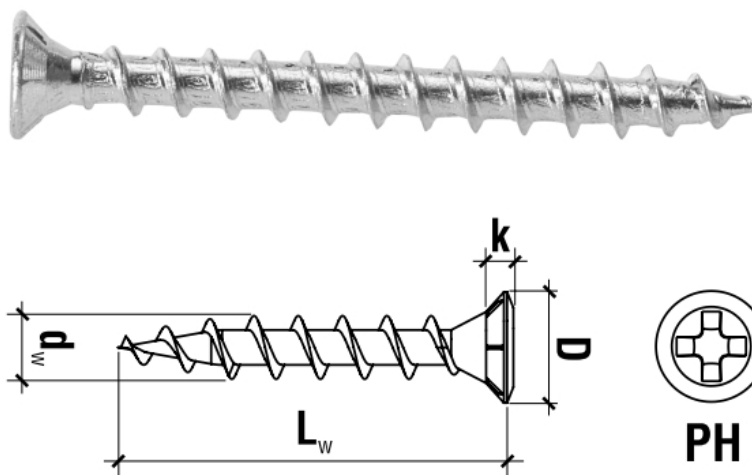

Product Code	Size (mm)	Head (mm)	Driver	Material	Box Quantity
9051255	4 x 16	7.3	PH2	Galvanised	1000 pcs
9051256	4 x 20	7.3	PH2	Galvanised	1000 pcs
9051257	4 x 25	7.3	PH2	Galvanised	1000 pcs
9051258	4 x 30	7.3	PH2	Galvanised	1000 pcs
9051259	4 x 35	7.3	PH2	Galvanised	500 pcs
9051260	4 x 40	7.3	PH2	Galvanised	500 pcs
9051261	4 x 45	7.3	PH2	Galvanised	500 pcs
9051262	4 x 50	7.3	PH2	Galvanised	500 pcs
9051263	4 x 55	7.3	PH2	Galvanised	500 pcs

*Note: Various driver bits are available. Please refer to drivers section at the end of this catalogue.



Catalogue not up to date?
Scan the QR or [click here](#)
to view the latest version

[Click to jump back to top](#)

Spax Self Drilling Screw

Spax FEX-A window construction screw suitable for anchoring steel reinforcement to uPVC profiles.

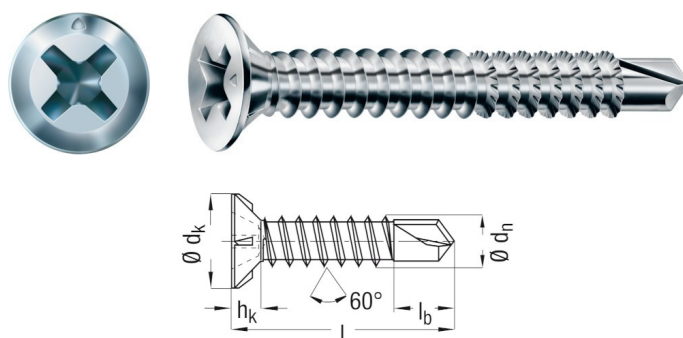

Product Code	Size (mm)	Head (mm)	Driver	Material	Coating	Box Quantity
1401470390165	3.9 x 16	7.5	PH2	Steel	Wirox	1000 pcs
1401470390195	3.9 x 19	7.5	PH2	Steel	Wirox	1000 pcs
1401470390255	3.9 x 25	7.5	PH2	Steel	Wirox	1000 pcs
1401470390325	3.9 x 32	7.5	PH2	Steel	Wirox	1000 pcs
1401470390385	3.9 x 38	7.5	PH2	Steel	Wirox	1000 pcs

*Note: Various driver bits are available. Please refer to drivers section at the end of this catalogue.



Catalogue not up to date?
Scan the QR or [click here](#)
to view the latest version

[Click to jump back to top](#)

Spax Hardware Screw

Spax universal needle point screw with 4CUT head and Wirox coating.

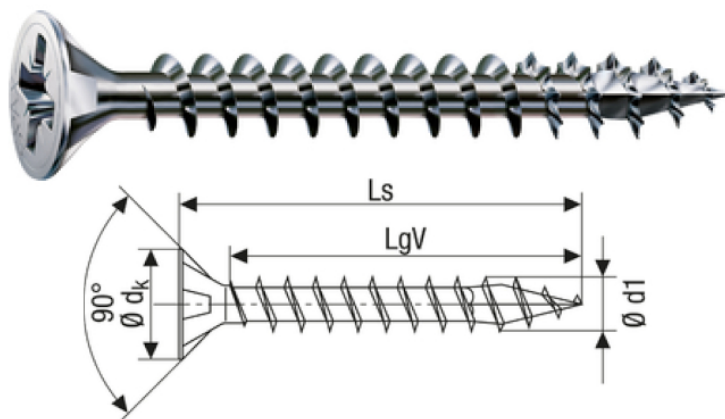

Product Code	Size (mm)	Driver	Material	Coating	Box Quantity
1081010400165	4 x 16	PH2	Steel	Wirox	1000 pcs
1081010400255	4 x 25	PH2	Steel	Wirox	1000 pcs
35704012301011	4 x 30	PH2	Steel	Wirox	1000 pcs
1081010400405	4 x 40	PH2	Steel	Wirox	1000 pcs

*Note: Various driver bits are available. Please refer to drivers section at the end of this catalogue.



Catalogue not up to date?
Scan the QR or [click here](#)
to view the latest version

[Click to jump back to top](#)

Dresselhaus Threaded Screw

Fully threaded machine screws suitable for window handle installation. Wide variety of sizes to suit different uPVC profiles.

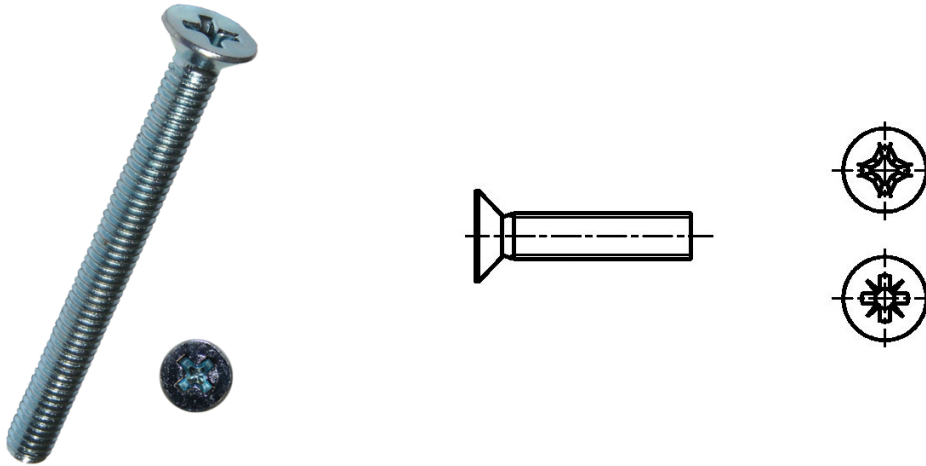

Product Code	Size (mm)	Material	DIN	Driver	Box Quantity
032679	5 x 45	Galvanised	965	PH2	500
0125027	5 x 50	Galvanised	965	PH2	500
4026303950893	5 x 80	Galvanised	965	PH2	200
4026303950909	5 x 90	Galvanised	965	PH2	100
4026303950916	5 x 100	Galvanised	965	PH2	200
4001796574207	6 x 30	Galvanised	965	PH2	200
4001796574269	6 x 45	Galvanised	965	PH2	200
4001796574283	6 x 50	Galvanised	965	PH2	200
4001796574313	6 x 60	Galvanised	965	PH2	200
4026303950923	6 x 70	Galvanised	965	PH2	200
4026303950947	6 x 90	Galvanised	965	PH2	100
4026303950954	6 x 100	Galvanised	965	PH2	100

*Note: Various driver bits are available. Please refer to drivers section at the end of this catalogue.



Catalogue not up to date?
Scan the QR or [click here](#)
to view the latest version

[Click to jump back to top](#)

Parco® Screw Cover Caps



Product Code	Colour	Driver	Bag Quantity
60411G	Pure White - RAL9010	TX30	200



Catalogue not up to date?
Scan the QR or [click here](#)
to view the latest version

[Click to jump back to top](#)

Dresselhaus Screw Cover Caps

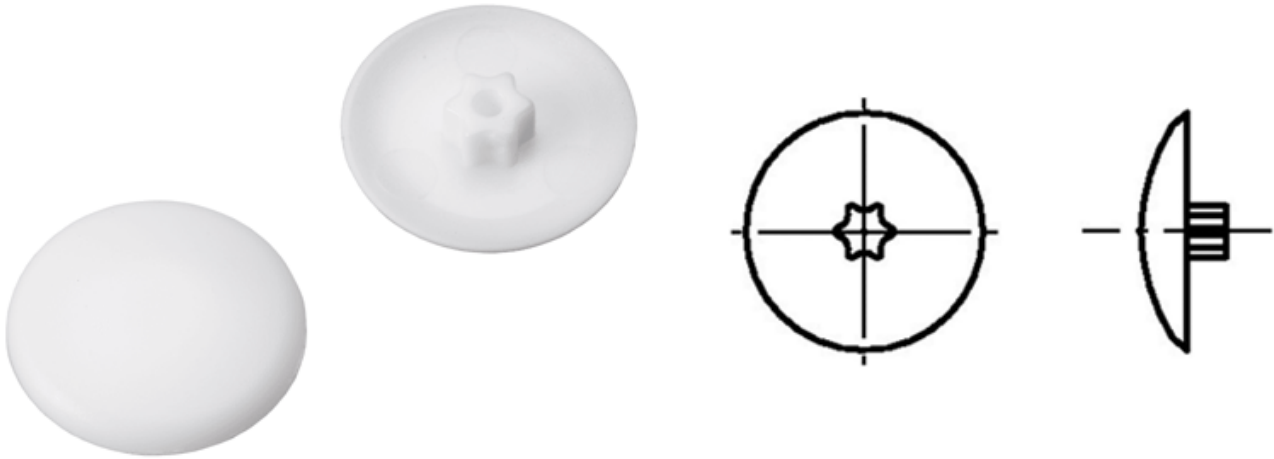

Product Code	Colour	Driver	Bag Quantity
0/7694/733/01	Light Oak - Colour 59	T30	200
0/7694/677/01	Black RAL9005	T30	200
4026303760485	White RAL9010	T30	200
4042991109061	Beige Brown RAL1011	T30	1000



Catalogue not up to date?
Scan the QR or [click here](#)
to view the latest version

[Click to jump back to top](#)

Stroxx Driver Bits

Stroxx driver bits. 3 drivers per packing unit.



Product Code	Drive	Length (mm)	Colour	Packaging unit
0009075805	PH1	90	Yellow	1
0009075806	PH2	90	White	1
0009075807	PH3	90	Red	1
0009075811	TX10	90	Blue	1
0009075812	TX15	90	Yellow	1
0009075813	TX20	90	White	1
0009075834	TX25	90	Black	1
0009075835	TX30	90	Red	1
09075837	HEX 4mm	50	Orange	1
0009075838	HEX 4mm	70	Orange	1
0009075840	HEX 5mm	70	Green	1
09075839	HEX 5mm	50	Green	1



Catalogue not up to date?
Scan the QR or [click here](#)
to view the latest version

[Click to jump back to top](#)

Parco / Jet Fast Driver Bits

Driver bits from Parco & JetFast.



Product Code	Description	Drive	Bits per pack	Packaging unit
117TE650	Jet-Fast Driver Bit	TX20	10	1
1130TX20	Jet-Fast Driver Bit	TX20	10	1
1130TX30	Jet-Fast Driver Bit	TX30	10	1
451TX20	Standard driver bit	TX20	10	1
451TX40	Standard driver bit	TX40	10	1



Catalogue not up to date?
Scan the QR or [click here](#)
to view the latest version

[Click to jump back to top](#)

PARCO Multifunction Sleeve

Expansion-free metal dowel with metric internal thread



Product Code	Description	Drill	Thread	Minimum drill hole depth	Installation depth	Packing Unit
613S6	Threaded insert	9	M6	47	42	50
613S8	Threaded insert	12	M8	48	43	25
613S10	Threaded insert	15	M10	33	28	15
613S12	Threaded insert	18	M12	37	32	10
613S16	Threaded insert	22	M16	42	37	5

*Dimensions in mm



Catalogue not up to date?
Scan the QR or [click here](#)
to view the latest version

[Click to jump back to top](#)

blaugelb Glazing Block - 1mm - White

High load bearing capacity, optimal load distribution, aging and temperature resistant. Labyrinth ventilation system for optimum ventilation and drainage.



Product Code	Description	Height x Width (mm)	Colour	Packaging Unit
0416374	Polypropylene glazing block	20 x 100	white	1000
0416390	Polypropylene glazing block	24 x 100	white	1000
0416403	Polypropylene glazing block	28 x 100	white	1000
0416415	Polypropylene glazing block	32 x 100	white	1000
0416421	Polypropylene glazing block	34 x 100	white	1000



Catalogue not up to date?
Scan the QR or [click here](#)
to view the latest version

[Click to jump back to top](#)

blaugelb Glazing Block - 2mm - Blue

High load bearing capacity, optimal load distribution, aging and temperature resistant. Labyrinth ventilation system for optimum ventilation and drainage.

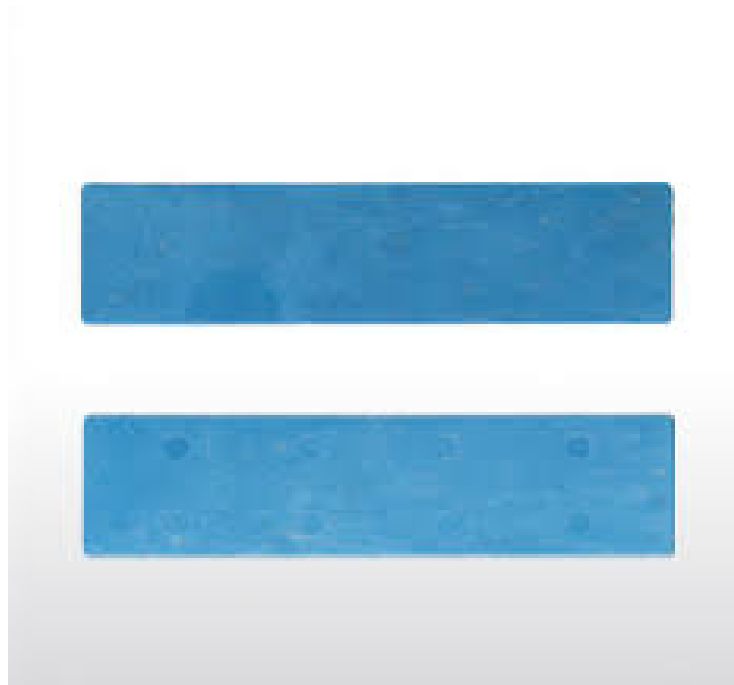

Product Code	Description	Height x Width (mm)	Colour	Packaging Unit
0416375	Polypropylene glazing block	20 x 100	blue	1000
0416391	Polypropylene glazing block	24 x 100	blue	1000
0416404	Polypropylene glazing block	28 x 100	blue	1000
0416416	Polypropylene glazing block	32 x 100	blue	1000
0416422	Polypropylene glazing block	34 x 100	blue	1000
0416436	Polypropylene glazing block	40 x 100	blue	1000
0416447	Polypropylene glazing block	46 x 100	blue	1000



Catalogue not up to date?
Scan the QR or [click here](#)
to view the latest version

[Click to jump back to top](#)

blaugelb Glazing Block - 3mm - Red

High load bearing capacity, optimal load distribution, aging and temperature resistant. Labyrinth ventilation system for optimum ventilation and drainage.

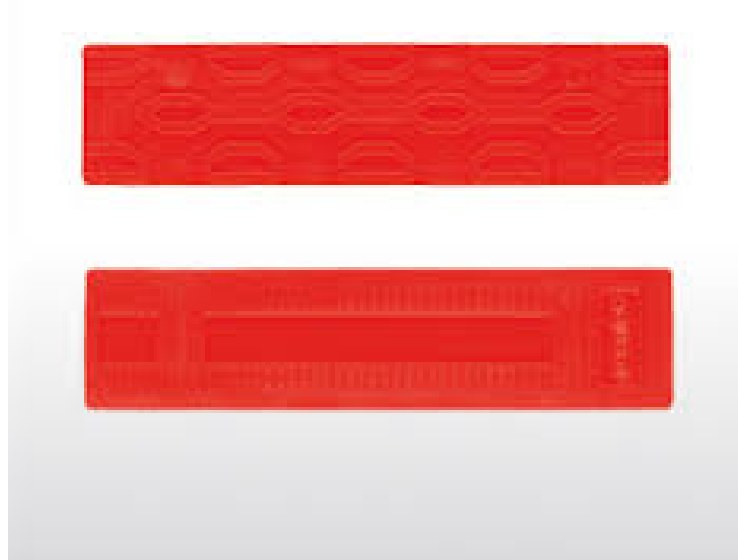

Product Code	Description	Height x Width (mm)	Colour	Packaging Unit
0416376	Polypropylene glazing block	20 x 100	red	1000
0416392	Polypropylene glazing block	24 x 100	red	1000
0416405	Polypropylene glazing block	28 x 100	red	1000
0416417	Polypropylene glazing block	32 x 100	red	1000
0416423	Polypropylene glazing block	34 x 100	red	1000
0416442	Polypropylene glazing block	44 x 100	red	500
0416448	Polypropylene glazing block	46 x 100	red	500



Catalogue not up to date?
Scan the QR or [click here](#)
to view the latest version

[Click to jump back to top](#)

blaugelb Glazing Block - 4mm - Yellow

High load bearing capacity, optimal load distribution, aging and temperature resistant. Labyrinth ventilation system for optimum ventilation and drainage.



Product Code	Description	Height x Width (mm)	Colour	Packaging Unit
0416377	Polypropylene glazing block	20 x 100	yellow	1000
0416393	Polypropylene glazing block	24 x 100	yellow	1000
0416406	Polypropylene glazing block	28 x 100	yellow	1000
0416418	Polypropylene glazing block	32 x 100	yellow	1000
0416424	Polypropylene glazing block	34 x 100	yellow	500
0416438	Polypropylene glazing block	40 x 100	yellow	500
0416449	Polypropylene glazing block	46 x 100	yellow	500



Catalogue not up to date?
Scan the QR or [click here](#)
to view the latest version

[Click to jump back to top](#)

blaugelb Glazing Block - 5mm - Green

High load bearing capacity, optimal load distribution, aging and temperature resistant. Labyrinth venilation system for optimum ventilation and drainage.

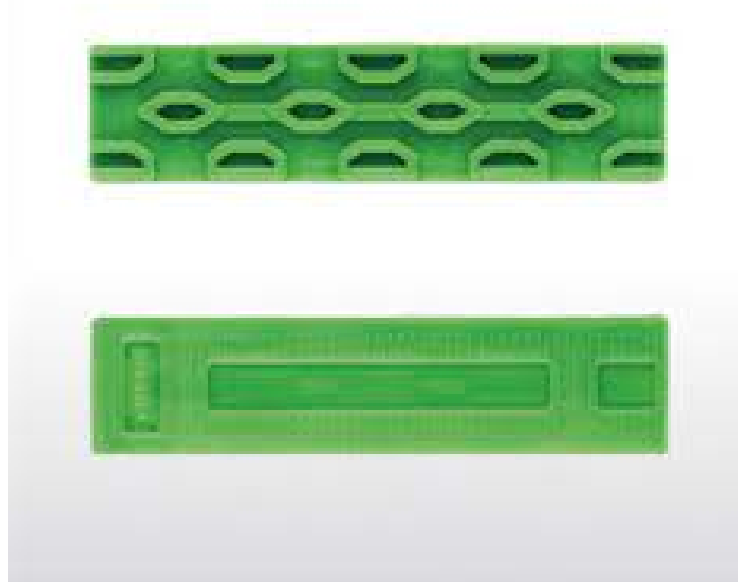

Product Code	Description	Height x Width (mm)	Colour	Packaging Unit
0416378	Polypropylene glazing block	20 x 100	green	1000
0416394	Polypropylene glazing block	24 x 100	green	1000
0416407	Polypropylene glazing block	28 x 100	green	500
0416419	Polypropylene glazing block	32 x 100	green	500
0416425	Polypropylene glazing block	34 x 100	green	500
0416439	Polypropylene glazing block	40 x 100	green	500
0416444	Polypropylene glazing block	44 x 100	green	500
0416450	Polypropylene glazing block	46 x 100	green	500



Catalogue not up to date?
Scan the QR or [click here](#)
to view the latest version

[Click to jump back to top](#)

blaugelb Glazing Block - 6mm - Black

High load bearing capacity, optimal load distribution, aging and temperature resistant. Labyrinth ventilation system for optimum ventilation and drainage.



Product Code	Description	Height x Width (mm)	Colour	Packaging Unit
0416379	Polypropylene glazing block	20 x 100	black	1000
0416395	Polypropylene glazing block	24 x 100	black	1000
0416408	Polypropylene glazing block	28 x 100	black	500
0416420	Polypropylene glazing block	32 x 100	black	500
0416426	Polypropylene glazing block	34 x 100	black	500
0416451	Polypropylene glazing block	46 x 100	black	250



Catalogue not up to date?
Scan the QR or [click here](#)
to view the latest version

[Click to jump back to top](#)

Medos Glazing Paddle

Medos plastic glazing paddle



Product Code	Description	Material	Packaging Unit
7620000002	Glazing Paddle	Plastic	1



Catalogue not up to date?
Scan the QR or [click here](#)
to view the latest version

[Click to jump back to top](#)

Fortis Glazing Hammer

Hammer for gentle striking without damaging the workpieces



Product Code	Description	Size (mm)	Packaging Unit
4317784779074	Glazing hammer	22	1
4317784786348	Glazing hammer	27	1
4317784786331	Glazing hammer	32	1



Catalogue not up to date?
Scan the QR or [click here](#)
to view the latest version

[Click to jump back to top](#)

Soudaglatt

Flexible smoothing tool made from a specific plastic for the tooling of sealing tools. The specially developed tool edges enable the fast and easy tooling required to achieve perfectly smooth joints.



Product Code	Description	Packaging Unit
113509	Flexible smoothing tool	1



Catalogue not up to date?
Scan the QR or [click here](#)
to view the latest version

[Click to jump back to top](#)

Stroxx Driver Bits

Stroxx driver bits. 3 drivers per packing unit.



Product Code	Drive	Length (mm)	Colour	Packaging unit
0009075805	PH1	90	Yellow	1
0009075806	PH2	90	White	1
0009075807	PH3	90	Red	1
0009075811	TX10	90	Blue	1
0009075812	TX15	90	Yellow	1
0009075813	TX20	90	White	1
0009075834	TX25	90	Black	1
0009075835	TX30	90	Red	1
09075837	HEX 4mm	50	Orange	1
0009075838	HEX 4mm	70	Orange	1
0009075840	HEX 5mm	70	Green	1
09075839	HEX 5mm	50	Green	1



Catalogue not up to date?
Scan the QR or [click here](#)
to view the latest version

[Click to jump back to top](#)

Parco / Jet Fast Driver Bits

Driver bits from Parco & JetFast.



Product Code	Description	Drive	Bits per pack	Packaging unit
117TE650	Jet-Fast Driver Bit	TX20	10	1
1130TX20	Jet-Fast Driver Bit	TX20	10	1
1130TX30	Jet-Fast Driver Bit	TX30	10	1
451TX20	Standard driver bit	TX20	10	1
451TX40	Standard driver bit	TX40	10	1



Catalogue not up to date?
Scan the QR or [click here](#)
to view the latest version

[Click to jump back to top](#)

STROXX Bit Screwdriver Set

16 piece screwdriver set.



Product Code	Description	Packaging Unit
0427747	16pc screwdriver set	1



Catalogue not up to date?
Scan the QR or [click here](#)
to view the latest version

[Click to jump back to top](#)

TORX Screw Bit 1/4 Drive

For screwing in wood, metal and sheet metal. Particularly suitable for use with commercially available impact/impact wrenches.

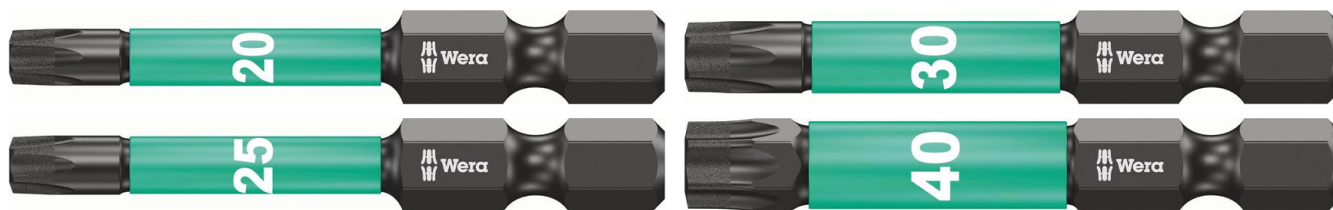

Product Code	Description	Size	Packaging Unit
6601006742	Impact bit	TX20	1
6601006997	Impact bit	TX25	1
6601007000	Impact bit	TX30	1
6601007003	Impact bit	TX40	1



Catalogue not up to date?
Scan the QR or [click here](#)
to view the latest version

[Click to jump back to top](#)

STROXX Drill Set

Twist drill set in industrail cassette



Product Code	Description	Pieces	Packaging Unit
0325515	HSS drill bits	19pc	1
0325517	HSS-G drill bits	19pc	1
0325516	HSS drill bits	25pc	1
0325518	HSS-G drill bits	25pc	1



Catalogue not up to date?
Scan the QR or [click here](#)
to view the latest version

[Click to jump back to top](#)

STROXX Drill Bit Set

100 piece HSS drill set in plastic case 1.00 - 10mm.



Product Code	Description	Pieces	Packaging Unit
0009082798	HSS drill bits	100pc	1



Catalogue not up to date?
Scan the QR or [click here](#)
to view the latest version

[Click to jump back to top](#)

STROXX Hammer Drill Bit Set

Robust tungsten carbide tip with four cutting edges, guarantees precise round drill holes, ideal for securely anchoring fasteners.



Product Code	Description	Pieces	Packaging Unit
9073299	Hammer drill bit set	6	1



Catalogue not up to date?
Scan the QR or [click here](#)
to view the latest version

[Click to jump back to top](#)

STROXX TWIST DRILL Piece HSS DIN340

For drilling work with higher stress and high concentricity in metal.



Product Code	Diameter	Overall Length	Packaging Unit
0069392	2.00	85	1
0069397	2.50	95	1
0069402	3.00	100	1
0069404	3.20	106	1
0069407	3.50	112	1
0069412	4.00	119	1
0069417	4.50	126	1
0069422	5.00	132	1
0069427	5.50	139	1
0069432	6.00	139	1
0069433	6.50	148	1
0069434	7.00	156	1
0069735	7.50	156	1
0069436	8.00	165	1
0069437	8.50	165	1
0069438	9.00	175	1
0069439	9.50	175	1
0069440	10.00	184	1
0069441	10.50	184	1
0069442	11.00	195	1
0069443	11.50	495	1
0069444	12.00	205	1
0069445	12.50	205	1
0069446	13.00	205	1

*Dimensions in mm



Catalogue not up to date?
Scan the QR or [click here](#)
to view the latest version

[Click to jump back to top](#)

STROXX TWIST DRILL Piece HSS DIN338

For drilling work with higher stress and high concentricity in metal.



Product Code	Diameter	Overall Length	Packaging Unit
0069998	1.00	34	1
0069999	1.50	40	1
0070000	2.00	49	1
0070001	2.50	57	1
0070002	3.00	61	1
0070006	3.50	70	1
0070008	4.00	75	1
0070011	4.50	80	1
0070013	5.00	86	1
0070016	5.50	93	1
0070018	6.00	93	1
0070020	6.50	101	1
0070022	7.00	109	1
0070023	7.50	109	1
0070024	8.00	117	1
0070026	8.50	117	1
0070027	9.00	125	1
0070028	9.50	125	1
0070029	10.00	133	1
0070031	10.50	133	1
0070032	11.00	142	1
0070033	11.50	142	1
0070034	12.00	151	1
0070035	12.50	151	1
0070036	13.00	151	1

*Dimensions in mm



Catalogue not up to date?
Scan the QR or [click here](#)
to view the latest version

[Click to jump back to top](#)

STROXX Wood Drill Bit Set

Wood drill bit set made of carbon steel. Drill bit lengths: 3, 4, 5, 6 and 8mm.



Product Code	Description	Packaging Unit
0009076910	Wood drill bit set	1



Catalogue not up to date?
Scan the QR or [click here](#)
to view the latest version

[Click to jump back to top](#)

STROXX SDS-PLUS Hammer Drill Bit Set

7 pc hammer drill bit set, robust tungsten carbide tip with four cutting edges, guarantees precise round drill holes, ideal for securely anchoring fasteners.



Product Code	Description	Packaging Unit
09073300	7pc Hammer drill bit set	1



Catalogue not up to date?
Scan the QR or [click here](#)
to view the latest version

[Click to jump back to top](#)

STROXX Drill Bit Set Hex

Drill bit set made of HSS metal, 2, 3, 4, 5 and 6mm lengths



Product Code	Description	Packaging Unit
0009076909	Drill bit set	1



Catalogue not up to date?
Scan the QR or [click here](#)
to view the latest version

[Click to jump back to top](#)

blaugelb Foam Gun

Metal foam gun used for PU foam cans. The rubberized handle is ergonomically shaped and ensures a secure grip and fatigue-free working.



Product Code	Description	Material	Packaging Unit
0361772	PU foam gun with 2 tapered nozzles	metal	1



Catalogue not up to date?
Scan the QR or [click here](#)
to view the latest version

[Click to jump back to top](#)

Foam Gun - 800 AMP PM - Eco & Standard

Adjustable gun for screw top PU foam cans.



Eco foam gun



Standard foam gun

Product Code	Description	Material	Packaging Unit
800AMPPMECO	PU foam gun - Eco	metal	1
800AMPPMSTANDARD	PU foam gun - Standard	metal	1



Catalogue not up to date?
Scan the QR or [click here](#)
to view the latest version

[Click to jump back to top](#)

Foam Gun - 800 AMP PM - Prestige & Ultra

Adjustable gun for screw top PU foam cans.



Prestige foam gun



Ultra foam gun

Product Code	Description	Material	Packaging Unit
800AMPPMPRESTIGE	PU foam gun - Prestige	metal	1
800AMPPMULTRAM	PU foam gun - Ultra	metal	1



Catalogue not up to date?
Scan the QR or [click here](#)
to view the latest version

[Click to jump back to top](#)

Economical PU Foam Gun

Foam Gun to suit screw top PU foams



Product Code	Description	Material	Packaging Unit
168707	PU Foam Gun Economical	Metal/Plastic	1



Catalogue not up to date?
Scan the QR or [click here](#)
to view the latest version

[Click to jump back to top](#)

Caulking Gun - 800 AMWM PR - Eco & Standard

For standard 310ml cartridges.



Eco silicone gun



Standard silicone gun

Product Code	Description	Material	Packaging Unit
800AMWMPRECO	Silicone gun - Eco	metal	1
800AMWPLRSTAND	Silicone gun - Standard	metal	1



Catalogue not up to date?
Scan the QR or [click here](#)
to view the latest version

[Click to jump back to top](#)

Caulking Gun - 800 AMW P - Prestige

For standard 310ml cartridges.



Product Code	Description	Material	Packaging Unit
800AMWMPRESTIGE	Silicone gun - Prestige	metal	1



Catalogue not up to date?
Scan the QR or [click here](#)
to view the latest version

[Click to jump back to top](#)

Medos Sausage Gun Ultra

Adjustable gun for sausages



Product Code	Description	Material	Packaging Unit
800AMWSULTRA	Sausage Gun Ultra	Metal	1



Catalogue not up to date?
Scan the QR or [click here](#)
to view the latest version

[Click to jump back to top](#)

Dripless HD Sausage Gun

A powerful heavy duty, trade quality sausage. Comes with aluminium and clear plastic interchangeable barrels.



Product Code	Description	Material	Packaging Unit
112802	Applicator gun for 600ml sausage	aluminium	1



Catalogue not up to date?
Scan the QR or [click here](#)
to view the latest version

[Click to jump back to top](#)

Medos Pistol

Adjustable gun for PU Corfix Duo



Product Code	Description	Material	Packaging Unit
50400009000	Pistol for PU Corfix Duo	Metal	1



Catalogue not up to date?
Scan the QR or [click here](#)
to view the latest version

[Click to jump back to top](#)

WinMax Flex

WinMax Specialty clamping tool for window installation.

Product Features:

-Maximum load: 50kg

-Joint width 9 mm - 22 mm

-WinMax protects the component and also the wall, as the tool can be easily and safely removed by simply turning the handle when the work is finished.

-The flexible shaft makes it possible to work even in inaccessible places.

-By simply turning the handle, the clamping surfaces expand, creating a high pressure between the window/door and the masonry. Now it is child's play to install the component with millimeter precision.

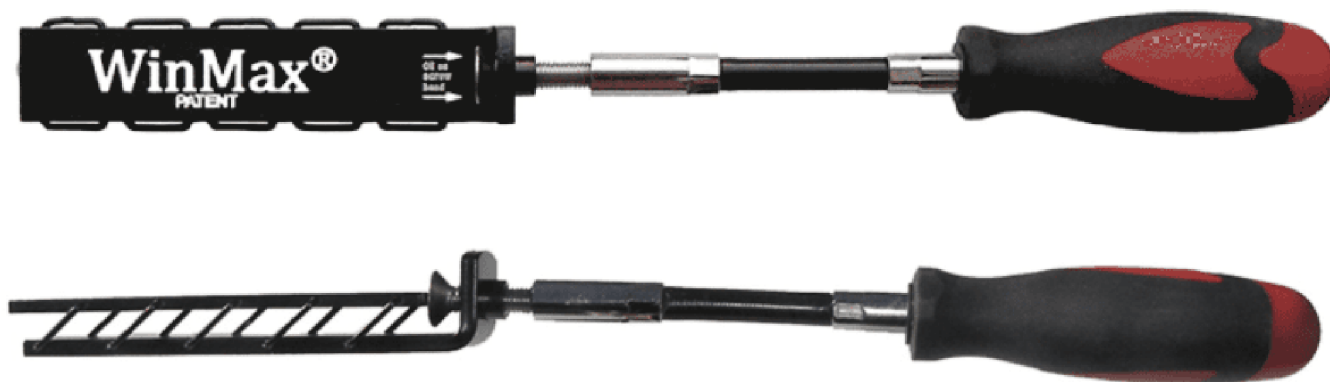

Product Code	Description	Packaging Unit
2400	WinMax Clamping Tool	1
2400_4	WinMax Clamping Tool - Pack of 4	1



Catalogue not up to date?
Scan the QR or [click here](#)
to view the latest version

[Click to jump back to top](#)

STROXX Window Installation Bag

4 piece window installation bag containing inflatable air cushions with a capacity of 135kg. Easily align heavy objects with millimeter precision and bring them into the optimal position. Suitable for joints from 2-50mm, the pads are non-slip and the hand pump with valve enables easy operation.



Product Code	Description	Weight (kg)	Packaging Unit
0009035152	Fixing pads - 4 pieces	135	1



Catalogue not up to date?
Scan the QR or [click here](#)
to view the latest version

[Click to jump back to top](#)

Bondhus Handle Alle Key

Ball End Hex Screwdriver



Product Code	Description	Size (mm)	Shank Length (mm)	Packaging Unit
BD10660	Allen Key	4	95	1
BD10760	Allen Key	4	179	1



Catalogue not up to date?
Scan the QR or [click here](#)
to view the latest version

[Click to jump back to top](#)

STROXX Allen Key Set

Nine allen keys in the dimensions from 1.5mm to 10mm.



Product Code	Surface	Packaging Unit
0009050814	matt chrome-plated	1



Catalogue not up to date?
Scan the QR or [click here](#)
to view the latest version

[Click to jump back to top](#)

Forum Latthammer

FORUM Latthammer With nail holder, hardened tubular steel handle and PVC handle, roughened track.



Product Code	Description	Weight	Packaging Unit
6601011500	Hammer	600g	1



Catalogue not up to date?
Scan the QR or [click here](#)
to view the latest version

[Click to jump back to top](#)

STROXX Soft-face Hammer

Non-recoiling soft-face hammer. Plastic coated tubular steel hammer, hammer head with steel ball filling.



Product Code	Description	Head Size (mm)	Packaging Unit
0009072812	Soft-face hammer	45	1



Catalogue not up to date?
Scan the QR or [click here](#)
to view the latest version

[Click to jump back to top](#)

STROXX Sledgehammer

Hickory club hammer



Product Code	Weight (g)	Packaging Unit
0009072810	1000	1



Catalogue not up to date?
Scan the QR or [click here](#)
to view the latest version

[Click to jump back to top](#)

Forum Screwdriver

Multi-component handle with roll-off protection, embossed head with drive symbol and size.



Product Code	Description	Overall Length (mm)	Blade Length (mm)	Flat (mm)	Packaging Unit
6601005533	Hex screwdriver	186	75	4.0	1
6601005581	Hex screwdriver	211	100	4.0	1
6601005536	Hex screwdriver	186	75	5.0	1
6601005584	Hex screwdriver	211	100	5.0	1



Catalogue not up to date?
Scan the QR or [click here](#)
to view the latest version

[Click to jump back to top](#)

STROXX Screwdriver Set

7 piece screwdriver set with galvanized tips



Product Code	Description	Packaging Unit
0009064958	7pc screwdriver set	1



Catalogue not up to date?
Scan the QR or [click here](#)
to view the latest version

[Click to jump back to top](#)

STROXX Angle Screwdriver Set

7 piece angle screwdriver set, with stand.

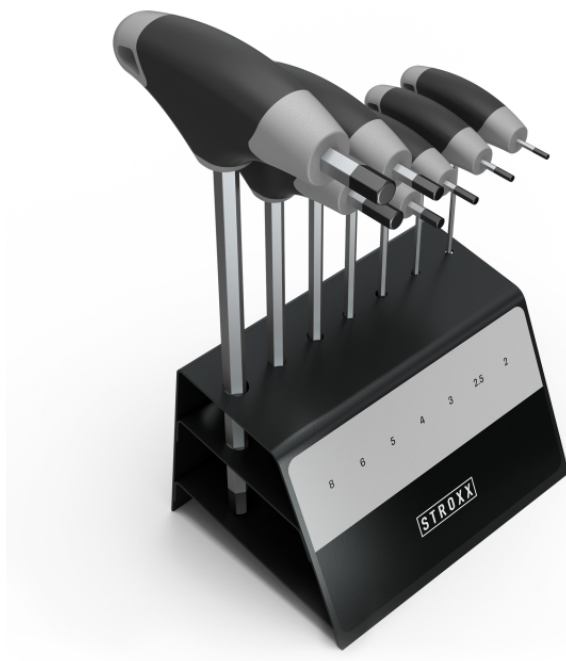

Product Code	Description	Pieces	Packaging Unit
0009083451	Angle screwdriver set	7	1



Catalogue not up to date?
Scan the QR or [click here](#)
to view the latest version

[Click to jump back to top](#)

Soudal Silicone Spatula Kit

7 Piece spatula kit.



Product Code	Description	Packaging Unit
222601	Silicone spatula kit	1



Catalogue not up to date?
Scan the QR or [click here](#)
to view the latest version

[Click to jump back to top](#)

STROXX Hacksaw

Metal hacksaw with aluminium frame and HSS bimetal saw blade.



Product Code	Length (mm)	Colour	Packaging Unit
0009094128	300	Black	1



Catalogue not up to date?
Scan the QR or [click here](#)
to view the latest version

[Click to jump back to top](#)

STROXX Hand Saw

Hand saw, black coated, hardened teeth



Product Code	Length (mm)	Packaging Unit
0009093973	450	1



Catalogue not up to date?
Scan the QR or [click here](#)
to view the latest version

[Click to jump back to top](#)

STROXX HSS Hole Saws Set

STROXX HSS Hole Saw Set, 11-Piece HSS Hole Saw Set 25-84 mm, Bimetal



Product Code	Description	Packaging Unit
0009082790	Hole saw set	1



Catalogue not up to date?
Scan the QR or [click here](#)
to view the latest version

[Click to jump back to top](#)

blaugelb Saber Saw Blade

Optimized blade shape with 130mm working blade, for maximum accessibility for timber and metal. Suitable for plunge cuts and can handle a wide variety of materials; including timber with nails / metal, chipboard, hard uPVC, GRP and epoxy.



Product Code	Description	Length (mm)	Material	Packaging Unit
9022628	Saber saw blade - 5 pieces	150	bi-metal	1



Catalogue not up to date?
Scan the QR or [click here](#)
to view the latest version

[Click to jump back to top](#)

STROXX Reciprocating Saw Blade

Reciprocating saw blade



Product Code	Description	Length (mm)	Packaging Unit
9131420	Reciprocating Saw Blade	150	5



Catalogue not up to date?
Scan the QR or [click here](#)
to view the latest version

[Click to jump back to top](#)

STROXX Replacement Saw Blades

STROXX Replacement Saw Blades for Hacksaw

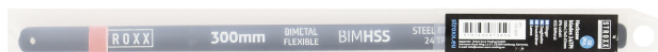

Product Code	Description	Length (mm)	Material	Packaging Unit
0009094127	Replacement blades	300	bi-metal	10



Catalogue not up to date?
Scan the QR or [click here](#)
to view the latest version

[Click to jump back to top](#)

blaugelb Jigsaw Blade - Quick Cut

Ideal for softer timbers in the construction area, and suitable for thick timber or fiberboard. Suitable for plunge cuts, long service life.



Product Code	Description	Length (mm)	Material	Packaging Unit
9022632	Jigsaw blade - 5 pieces	100	steel	1
9022631	Jigsaw blade - 5 pieces	152	steel	1



Catalogue not up to date?
Scan the QR or [click here](#)
to view the latest version

[Click to jump back to top](#)

blaugelb Jigsaw Blade - Clean Cut

Ideal for softer timbers in the construction area. Suitable for plunge cuts, with 72mm working length and 2.7 mm tooth pitch, long service life.



Product Code	Description	Length (mm)	Material	Packaging Unit
9022633	Jigsaw blade - 5 pieces	100	steel	1



Catalogue not up to date?
Scan the QR or [click here](#)
to view the latest version

[Click to jump back to top](#)

Foldable Ruler

2m folding rulers



0009068508



0009107833



6601018405

Product Code	Description	Material	Length (m)	Packaging Unit
0009068508	Foldable ruler	Plastic	2	1
0009107833	Foldable ruler (12 links)	Timber	2	1
6601018405	Foldable ruler	Timber	2	1



Catalogue not up to date?
Scan the QR or [click here](#)
to view the latest version

[Click to jump back to top](#)

STROXX Spirit Level

Shock proof (impact resistant) spirit levels in black design, and UV resistant



Product Code	Description	Length (mm)	Packaging Unit
0009072662	Spirit level 100-443	40	1
0009072663	Spirit level 100-445	60	1
0009072664	Spirit level 100-446	80	1
0009072665	Spirit level 100-447	100	1
0009072666	Spirit level with magnet 100-453	40	1
0009072667	Spirit level with magnet 100-454	60	1
0009072806	Spirit level with magnet 100-455	120	1



Catalogue not up to date?
Scan the QR or [click here](#)
to view the latest version

[Click to jump back to top](#)

Forum Cable Knife

Foldable 1-piece knife with timber handle, blade with notch.



Product Code	Description	Length (mm)	Packaging Unit
6601008575	Cable knife	195	1



Catalogue not up to date?
Scan the QR or [click here](#)
to view the latest version

[Click to jump back to top](#)

STROXX Multi-tool - 14 in 1

Multi -function tool and case, with needle nose pliers, flat nose pliers, side-cutters, serrated cutting edge, flat-blade screwdriver, Phillips screwdriver, knife blade, nailer, file with flat-blade screwdriver, mandrel, medium flat-blade screwdriver, bottle opener and screwdriver.



Product Code	Description	Packaging Unit
9071034	Multifunction tool	1



Catalogue not up to date?
Scan the QR or [click here](#)
to view the latest version

[Click to jump back to top](#)

STROXX utility Knife & snap blade

Cutter knife with 18mm snap-off blade.



Product Code	Description	Blade width (mm)	Packaging Unit
0009052741	Aluminium frame	18	1
0009052749	Plastic frame	18	1
0009071399	Snap blades - 50pc	18	1



Catalogue not up to date?
Scan the QR or [click here](#)
to view the latest version

[Click to jump back to top](#)

Bahco Professional Knife

Robust knife with solid stainless steel blade for a wide range of uses



Product Code	Blade Length	Packaging Unit
316016	102mm	1



Catalogue not up to date?
Scan the QR or [click here](#)
to view the latest version

[Click to jump back to top](#)

Fortis Work Knife

Fortis industrial knife with leather case



Product Code	Description	Packaging Unit
4317784728034	175mm knife	1



Catalogue not up to date?
Scan the QR or [click here](#)
to view the latest version

[Click to jump back to top](#)

Forum Japansaw

Saw for cutting to length, deep cuts, due to flexible blade also excellent for working in hard-to-reach places.



Product Code	Description	Packaging Unit
6601015811	270mm Blade	1



Catalogue not up to date?
Scan the QR or [click here](#)
to view the latest version

[Click to jump back to top](#)

Forum Carpenters Pull Saw

Combined saw with trapezoidal teeth for cross-sections and triangular toothing for longitudinal sections.



Product Code	Description	Packaging Unit
6601015793	Pull saw	1



Catalogue not up to date?
Scan the QR or [click here](#)
to view the latest version

[Click to jump back to top](#)

Friess Moon Knife Set

Quarter moon knife set including bag and slide



Product Code	Description	Packaging Unit
0382289	Moon knife set	1



Catalogue not up to date?
Scan the QR or [click here](#)
to view the latest version

[Click to jump back to top](#)

STROXX Folding Knife

STROXX folding knife with rubber handle and black titanium blade



Product Code	Description	Blade Length (cm)	Packaging Unit
0009071035	Folding knife	9.5	1



Catalogue not up to date?
Scan the QR or [click here](#)
to view the latest version

[Click to jump back to top](#)

STROXX Lashing Strap 2-part with Tension Ratchet & S-hook

The lashing strap enables goods to be transported safely, are abrasion resistant and have a high load capacity.



Product Code	Description	Width (mm)	Length (m)	Load capacity (kg)	Packaging Unit
0009072994	Ratchet strap	25	4	1500	1



Catalogue not up to date?
Scan the QR or [click here](#)
to view the latest version

[Click to jump back to top](#)

STROXX Lashing Strap 1-part with Clamp Lock

The lashing strap enables goods to be transported safely, are abrasion resistant and have a high load capacity.



Product Code	Description	Width (mm)	Length (m)	Load capacity (kg)	Packaging Unit
0009072998	Ratchet strap	25	5	400	1



Catalogue not up to date?
Scan the QR or [click here](#)
to view the latest version

[Click to jump back to top](#)

STROXX Lashing Strap 2-part with Tension Ratchet & Claw Hook

The lashing strap enables goods to be transported safely, are abrasion resistant and have a high load capacity



Product Code	Description	Width (mm)	Length (m)	Load capacity (kg)	Packaging Unit
0009072995	HD ratchet strap	35	6	1500	1



Catalogue not up to date?
Scan the QR or [click here](#)
to view the latest version

[Click to jump back to top](#)

STROXX Lashing Strap 1-part with Clamp Lock

The lashing strap enables goods to be transported safely, are abrasion resistant and have a high load capacity.

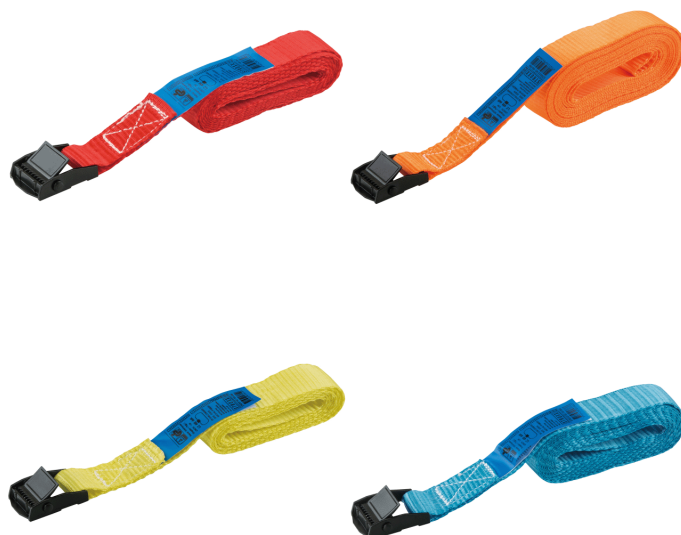

Product Code	Description	Width (mm)	Length (m)	Load capacity (kg)	Packaging Unit
0009072999	Yellow Lashing strap	25	1.5	200	1
0009073000	Red Lashing strap	25	2	200	1
0009073001	Blue Lashing strap	25	2.5	200	1
9073002	Orange Lashing strap	25	3	200	1



Catalogue not up to date?
Scan the QR or [click here](#)
to view the latest version

[Click to jump back to top](#)

Forum Mitre Scissors

FORUM Mitre scissors with 2 stops of 45° for strips made of wood and plastic, 55 mm cutting length.



Product Code	Description	Packaging Unit
6601016117	Mitre scissors	1
6601016118	Replacement blade	1



Catalogue not up to date?
Scan the QR or [click here](#)
to view the latest version

[Click to jump back to top](#)

STROXX Tin Scissor Set

Includes 1 x 10" left pair, 1 x 10" straight, 1 x 10" right pair.



Product Code	Description	Packaging Unit
0009067893	Sheet metal scissor set	1



Catalogue not up to date?
Scan the QR or [click here](#)
to view the latest version

[Click to jump back to top](#)

STROXX Chisel Set

5 piece chisel set, blade widths: 6, 10, 16, 20, 25 mm



Product Code	Description	Packaging Unit
0009049749	chisel set	1



Catalogue not up to date?
Scan the QR or [click here](#)
to view the latest version

[Click to jump back to top](#)

STROXX One-hand Clamp

STROXX one-hand clamp in STROXX design.



Product Code	Description	Clamp Range (mm)	Packaging Unit
0009077286	Clamp	0-300	1
0009077287	Clamp	0-450	1
0009077288	Clamp	0-600	1
0009077289	Clamp	0-900	1



Catalogue not up to date?
Scan the QR or [click here](#)
to view the latest version

[Click to jump back to top](#)

Medos Pressure Roll

Pressure Roll for:
Tapes
Wallpaper
etc.



Product Code	Packaging Unit
MDSROL	1



Catalogue not up to date?
Scan the QR or [click here](#)
to view the latest version

[Click to jump back to top](#)

STROXX Telescopic Assembly Support

Ceiling and assembly support for dry lining and timber beams, provides easy assistance for ceilings and sloping walls. Extendable from 1.6-2.9m, with a 90kg maximum weight at 90 deg, and a 40kg maximum weight at 65 deg.



Product Code	Description	Size (m)	Packaging Unit
0009072641	Telescopic support rod	1.6 - 2.9	1



Catalogue not up to date?
Scan the QR or [click here](#)
to view the latest version

[Click to jump back to top](#)

STROXX Folding Trestle

Foldable 78.1 x 99.1 cm trestle table with steel frame and anti slip pad. Easily collapsible for storage, and two hooks on the side enable the solid assembly of two work trestles.



Product Code	Description	Weight (kg)	Packaging Unit
0009071990	Foldable trestle	136	1



Catalogue not up to date?
Scan the QR or [click here](#)
to view the latest version

[Click to jump back to top](#)

Fugen Meister Radius Joint Spatula Set

Spreader for defined bevels and efficient smoothing on movement joints, connections joints and corner joints. Consists of radius of 4mm & 6mm, 8mm & 10mm, and 12mm & 14mm.



Product Code	Description	Packaging Unit
6601024133	Spatula joint pack - 3 piece	1



Catalogue not up to date?
Scan the QR or [click here](#)
to view the latest version

[Click to jump back to top](#)

Fugen Meister Angle Joint Spatula Set

Spreader for defined bevels and efficient smoothing on movement joints, connections joints and corner joints. Consists of angles measuring 5mm & 6mm, 8mm & 10mm, and a 90° angle, and a radius of 3mm.



Product Code	Description	Packaging Unit
6601024136	Spatula joint pack - 3 piece	1



Catalogue not up to date?
Scan the QR or [click here](#)
to view the latest version

[Click to jump back to top](#)

Ramsauer Rapid Cutter

Light weight cutter designed for opening sealant cartridges and cutting nozzles



Product Code	Description	Packaging Unit
9400200	Rapid cutter	1



Catalogue not up to date?
Scan the QR or [click here](#)
to view the latest version

[Click to jump back to top](#)

Dust Pan & Brush

Metal dustpan with long timber handle. Industrial hand brush with coconut and raw timber



Product Code	Description	Packaging Unit
6601018028	Dustpan	1
6601018016	Dustpan brush 45cm	1



Catalogue not up to date?
Scan the QR or [click here](#)
to view the latest version

[Click to jump back to top](#)

Prof Brush Broom

The ideal broom for heavy use.



Product Code	Description	Packaging Unit
6601017968	Broom	1



Catalogue not up to date?
Scan the QR or [click here](#)
to view the latest version

[Click to jump back to top](#)

STROXX Brush Set

7 piece brush set with silk tips.



Product Code	Description	Packaging Unit
0009016404	7 piece brush set	1



Catalogue not up to date?
Scan the QR or [click here](#)
to view the latest version

[Click to jump back to top](#)

STROXX Open-end Wrench Set

The STROXX open-end wrench set contains sizes of wrenches from 8 to 19 millimetres



Product Code	Description	Packaging Unit
0000427748	9pc wrench set	1



Catalogue not up to date?
Scan the QR or [click here](#)
to view the latest version

[Click to jump back to top](#)

STROXX Open-end and Ring Ratchet Wrench Set

The STROXX open-end ratchet wrench set contains sizes of wrenches from 8 to 19 millimeters.



Product Code	Description	Packaging Unit
0000427749	9pc wrench set	1



Catalogue not up to date?
Scan the QR or [click here](#)
to view the latest version

[Click to jump back to top](#)

STROXX Bit Socket Wrench Set

The STROXX socket wrench set in a high-quality and robust plastic case is the highlight in every tool case thanks to the black STROXX design. The foam holder inside the box provides secure protection of the socket wrench set from scratches and bumps. In addition, the matt chrome-plated coating protects the tool from rust.



Product Code	Description	Packaging Unit
0000427746	Socket wrench set	1



Catalogue not up to date?
Scan the QR or [click here](#)
to view the latest version

[Click to jump back to top](#)

STROXX Laser Rangefinder

The STROXX laser rangefinder is the ideal tool for optical distance measurement, with which you can achieve a reliable measurement within a few clicks.



Product Code	Description	Packaging Unit
9022626	Laser rangefinder with canvas bag	1



Catalogue not up to date?
Scan the QR or [click here](#)
to view the latest version

[Click to jump back to top](#)

Window and Door Service Set

All-in-one maintenance set for windows and doors, featuring practical container sizes, adjustment tools, and refill solutions for ongoing servicing.

Kit includes:

- Hardware maintenance spray
- Lock cylinder lubricant
- Cleaning and care cloth
- Surface care product (aluminium, PVC, or wood)
- Seal care treatment
- Selection of adjustment and installation tools for window and door hardware systems



Product Code	Profile	Hardware Brand	Packing Unit
9257968	Timber	Siegenia	1 set
9257985	Timber	ROTO	1 set
9257996	uPVC	Siegenia	1 set
9257997	uPVC	ROTO	1 set
9257998	uPVC	MACO	1 set



Catalogue not up to date?
Scan the QR or [click here](#)
to view the latest version

[Click to jump back to top](#)

Fixing Wedges

Plastic wedges for adjustment and installation of windows and doors.

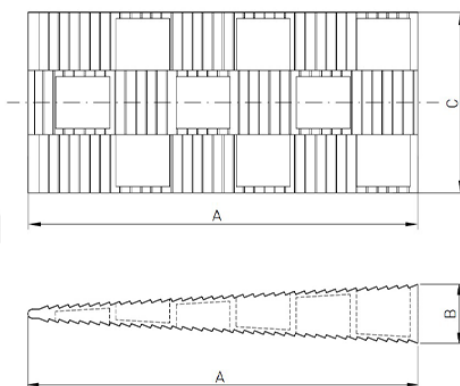
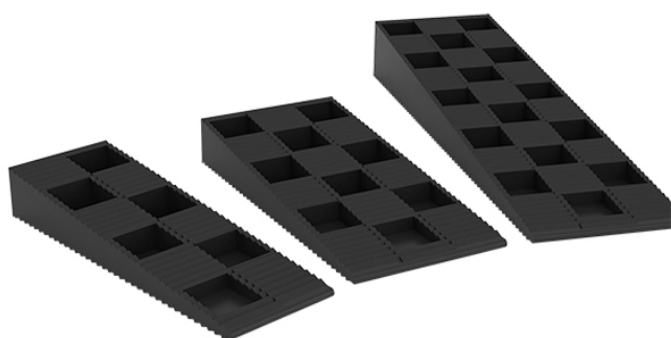

SIZE	A	B	C
S	94	14	29
M	94	14	43
L	150	20	43

Product Code	Description	Material	Box Qty
72714290000	Fixing wedge - small	plastic	500
72715450000	Fixing wedge - medium	plastic	500
72720450000	Fixing wedge - large	plastic	200



Catalogue not up to date?
Scan the QR or [click here](#)
to view the latest version

[Click to jump back to top](#)

KONIG Hard Wax Repair Kit

Repair kit for uPVC windows and laminate floors. Each kit contains:

- Soft Wax, 20x 4cm, series 720
- Hard Wax, 20x 4cm, wood, white and primary colours
- 1x Special Fillers Applicator
- 1x Hot Knife*
- 1x Sanding Pad coarse
- 1x Sanding Pad fine
- 1x Brush Pen Clear Lacquer, matt
- 1x Brush Pen Clear Lacquer, silk matt



Product Code	Description	Packaging Unit
0306690	uPVC repair kit	1
KO-294-999	Konig pen replacement tip	1



Catalogue not up to date?
Scan the QR or [click here](#)
to view the latest version

[Click to jump back to top](#)

blaugelb U Packers

Spacer mounting clips used for leveling, exact alignment, and lining in window and door construction as well as in the interior and plastering of ceilings, walls, and floor structures.

- fast compensation with millimeter precision, quick assembly
- universal use, for leveling, straightening and underlaying
- anti-slip protection with fixing hook
- non-positive direct load suspension
- made of high-quality polypropylene, high resistance to other chemical products



Product Code	Description	Size (mm)	Width (mm)	Box Qty
0416220	U packer	40 x 30	1	500
0416223	U packer	40 x 30	3	500
0416225	U packer	40 x 30	5	500
0416227	U packer	40 x 30	8	500
0416229	U packer	60 x 45	1	500
0416231	U packer	60 x 45	3	500
0416234	U packer	60 x 45	5	500
0416238	U packer	60 x 45	8	250



Catalogue not up to date?
Scan the QR or [click here](#)
to view the latest version

[Click to jump back to top](#)

Transporter Blocks

Extruded polystyrene rigid foam that has high compressive strength, and reliably absorbs pressure loads. Protect sensitive surfaces and fragile goods against damage during transport.



Product Code	Description	Size (mm)	Box Qty
0414504	Transporter blocks	48 x 48 x 10	3300
0414524	Transporter blocks	48 x 48 x 15	2700
0414525	Transporter blocks	48 x 48 x 20	2100
0414526	Transporter blocks	48 x 48 x 30	1500
0414529	Transporter blocks	48 x 48 x 50	900



Catalogue not up to date?
Scan the QR or [click here](#)
to view the latest version

[Click to jump back to top](#)

Furniture Packing Blanket

Packing blanket for safe transport protection due to the special fabric type of the blankets optimally protects even sensitive goods against dirt and damage during transport and storage



Product Code	Description	Size (mm)	Packaging Unit
6604003514	Packing blanket	2,000 x 1,500	1



Catalogue not up to date?
Scan the QR or [click here](#)
to view the latest version

[Click to jump back to top](#)

Fortis Temple Glasses

Clear protective glasses



Product Code	Description	Packaging Unit
6603015823	Clear safety glasses	1



Catalogue not up to date?
Scan the QR or [click here](#)
to view the latest version

[Click to jump back to top](#)

STROXX 2nd Life Glove

Allround glove 2nd life.



Product Code	Description	Size	Packaging Unit
09123738	2nd life glove	9	1
09123739	2nd life glove	10	1
09123740	2nd life glove	11	1



Catalogue not up to date?
Scan the QR or [click here](#)
to view the latest version

[Click to jump back to top](#)

STROXX Flexx Work Glove

Thin nylon/lycra knit glove - Actifresh, with PU/nitrile coated back of hand and finger.



Product Code	Description	Size	Packaging Unit
9073181	Flexx work glove	9	1 pair
9073182	Flexx work glove	10	1 pair
9073183	Flexx work glove	11	1 pair



Catalogue not up to date?
Scan the QR or [click here](#)
to view the latest version

[Click to jump back to top](#)

Heat Protective Gloves

The heat-resistant material offers protection against contact heat at a temperature of up to 260 °C over the entire length of 355 mm.



Product Code	Description	Packaging Unit
38054193706	Heat protective gloves	1



Catalogue not up to date?
Scan the QR or [click here](#)
to view the latest version

[Click to jump back to top](#)

3M Peltor Earmuffs



Product Code	Description	Packaging Unit
6603016399	Noise protecting earmuffs	1



Catalogue not up to date?
Scan the QR or [click here](#)
to view the latest version

[Click to jump back to top](#)

STROXX Black Cable Ties

Plastic cable ties that are UV resistant

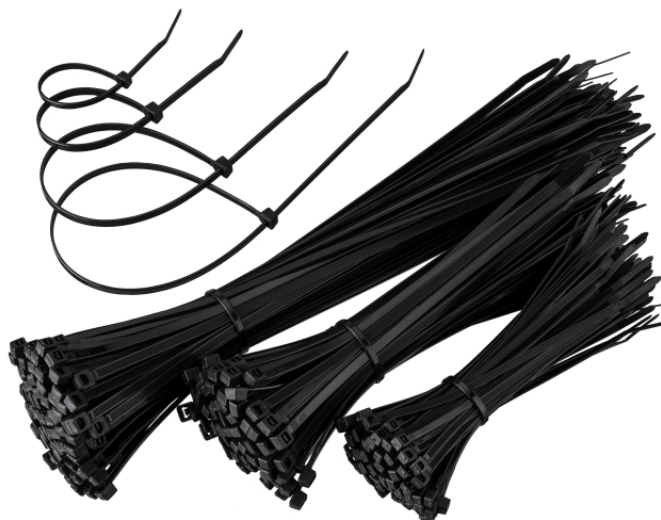

Product Code	Size (mm)	Packaging Unit
09128398	2.5 x 100	100
09128399	3.6 x 140	100
09128400	4.8 x 200	100
09128401	4.8 x 300	100
09128402	4.8 x 380	100



Catalogue not up to date?
Scan the QR or [click here](#)
to view the latest version

[Click to jump back to top](#)

STROXX Clear Cable Ties

Plastic cable ties that are UV resistant



Product Code	Size (mm)	Packaging Unit
09128403	2.5 x 100	100
09128414	3.6 x 150	100
09128415	4.8 x 200	100
09128416	4.8 x 300	100
09128417	4.8 x 380	100



Catalogue not up to date?
Scan the QR or [click here](#)
to view the latest version

[Click to jump back to top](#)

STROXX Microfibre Cleaning Wipes

The STROXX microfibre cloths are the perfect helper for everyday life. The static microfibre structure of the cloths allows for 3 times greater absorption of dirt, dust, oils and greases than is the case with conventional cotton cloths.



Product Code	Description	Packaging Unit
9066538	Microfibre cloths	4



Catalogue not up to date?
Scan the QR or [click here](#)
to view the latest version

[Click to jump back to top](#)

STROXX Painter and Cover Fleece Roll

Due to its material weight of 220 grams of cotton per square metre, the STROXX painter's and covering fleece is extra thick and can thus absorb even more liquid.

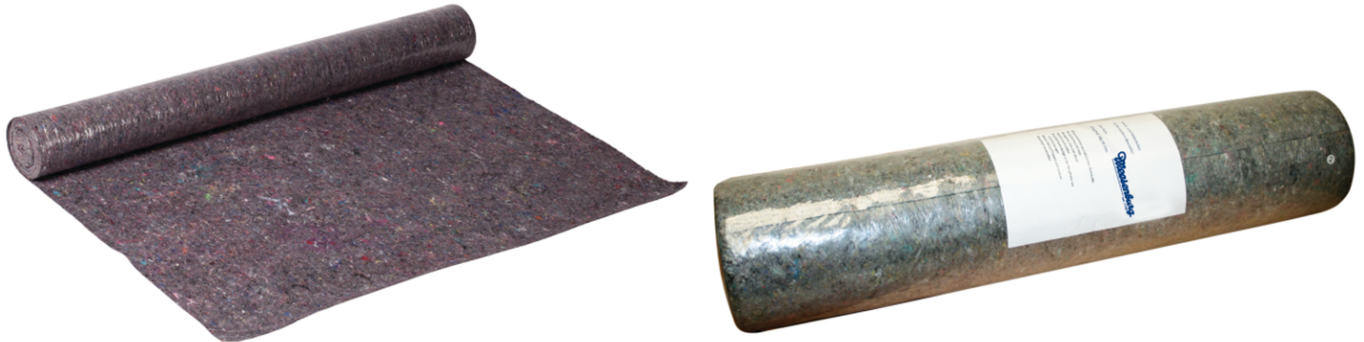

Product Code	Description	Length (m)	Packaging Unit
0401335	Painter felt roll	25	1
0409556	Painter felt roll	50	1



Catalogue not up to date?
Scan the QR or [click here](#)
to view the latest version

[Click to jump back to top](#)

STROXX Assortment Box

The grey and black box in a modern STROXX design and with a transparent lid shows you at first glance what is inside. 12 removable compartments keep your collection of small items, such as screws, nails and the like, organized.



Product Code	Description	Packaging Unit
0009052467	Plastic sotage box	1



Catalogue not up to date?
Scan the QR or [click here](#)
to view the latest version

[Click to jump back to top](#)

STROXX Tool Bag



Product Code	Description	Packaging Unit
9069679	Tool bag	1



Catalogue not up to date?
Scan the QR or [click here](#)
to view the latest version

[Click to jump back to top](#)

Ansell Armguards



Product Code	Description	Packaging Unit
76490475857	Armguard	1



Catalogue not up to date?
Scan the QR or [click here](#)
to view the latest version

[Click to jump back to top](#)

Soudal Zinc Spray MATT

High-grade zinc spray with sprayable zinccompound, 98% Acrylic



Product Code	Description	Size (mL)	Colour	Packaging Unit
155885	Zinc spray	400	Grey	6



Catalogue not up to date?
Scan the QR or [click here](#)
to view the latest version

[Click to jump back to top](#)

Consumables & Tools Catalogue

*53 Haddon Drive
PO Box 27
Ballan VIC 3342
Australia*

*+61 03 5368 1181
info@siegware.com.au
www.siegware.com.au
www.siegware.co.nz*